



# Installation Instructions







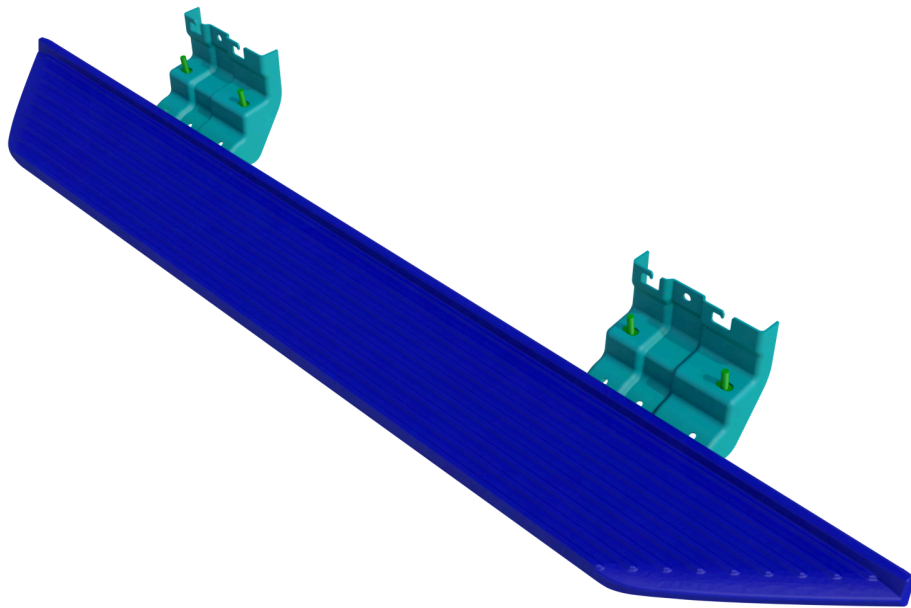

Part No. 2561+B

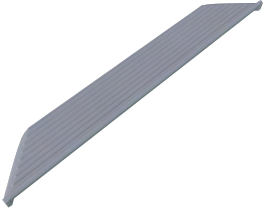
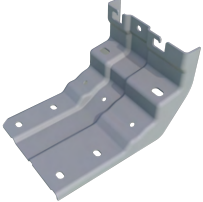
Vehicle: Ford Transit 2015-2025

Product: OEM Running Board Passenger Side

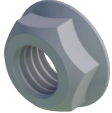

THANK YOU FOR CHOOSING OUR PRODUCT

Names	Pictures	Names	
(A) OEM Running Board		(B) Bracket (2 Pieces)	
(C) M8x1.25 Flange Hex-Bolt (4 Pieces)		(D) M8 Washer (8 Pieces)	
(E) M8 Lock Washer (8 Pieces)		(F) M8x1.25 Hex-Bolt Nut (4 Pieces)	
(G) M6x1.0 Flange Hex-Bolt (8 Pieces)		(H) M6 Washer (8 Pieces)	
(I) M6 Lock Washer (8 Pieces)			

Amount brackets (B) onto T-Slot inside of OEM Running Board (A) with M6x1.0 Flange Hex-Bolt (G/H/I), use M8x1.25 Flange Hex-Bolt (C/D/E and D/E/F) fixed brackets onto the vertical.

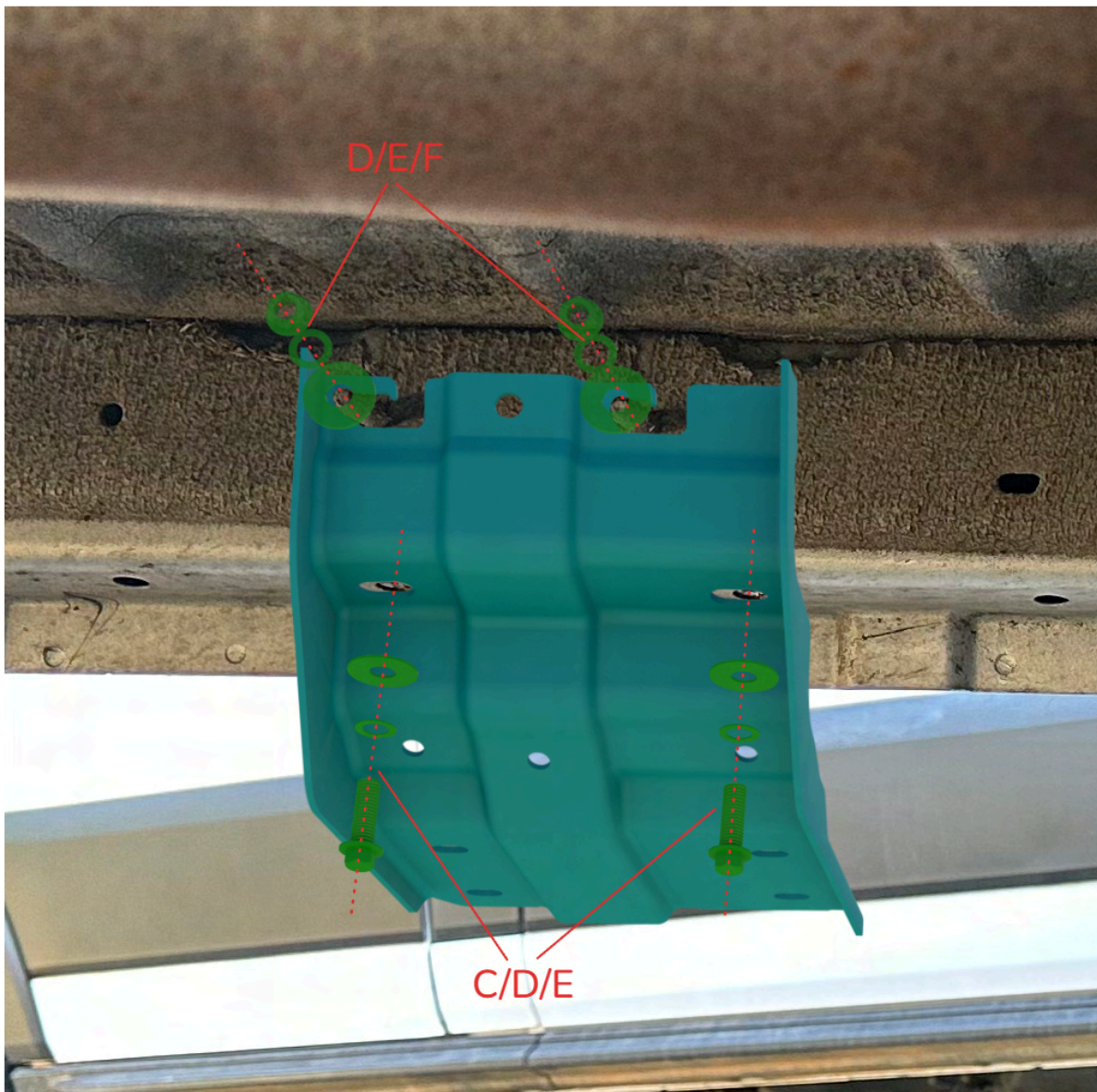
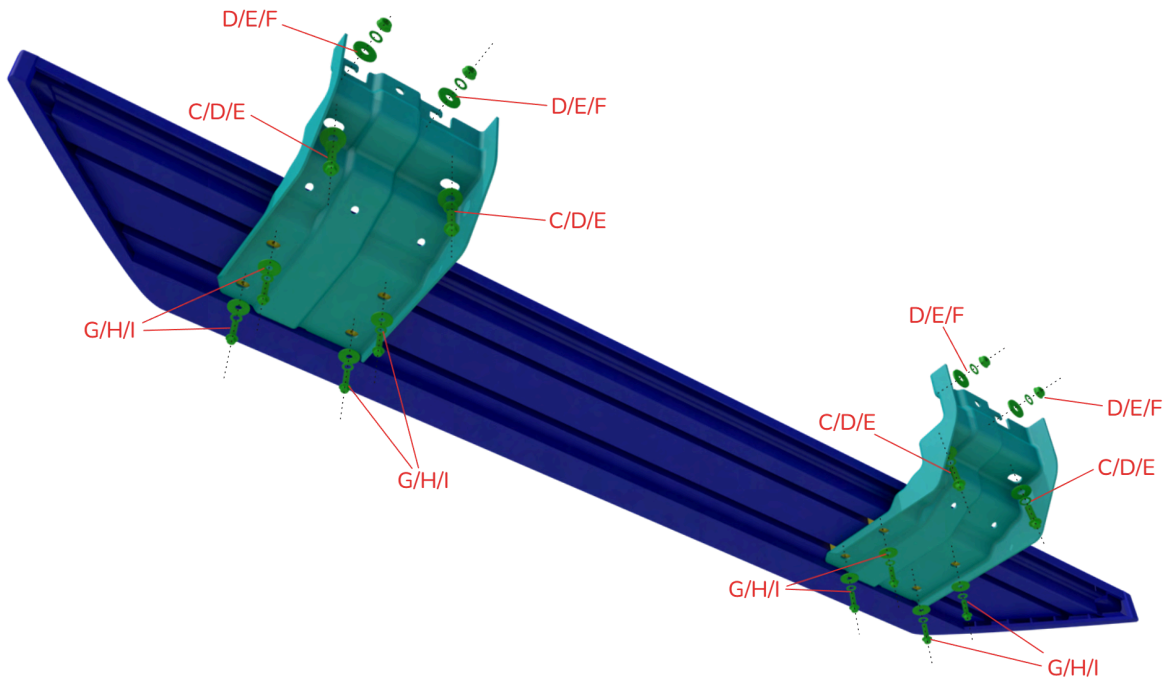



### **Step 1: Pre-tap the holes**

Use a high-torque wrench (or an impact wrench) to drive the provided self-tapping bolts into the chassis holes to cut the threads, then remove the bolts.



### **Step 2: Install the bracket**

Align the bracket with the newly tapped holes and secure it in place.

