

#2564B

## Installation Instruction

Thank you very much for choosing our products.  
Please read the installation instruction carefully before using our product and be sure to fully understand the contents mentioned above for subsequent installation.  
In addition, please keep properly the installation instruction for product maintenance in future.

### Attentions

- The following symbols are used in this installation instruction.



#### Caution

Relevant matters must be obeyed for safety.  
Non-compliance may result in injury or other accidents.  
Please read carefully and obey strictly.











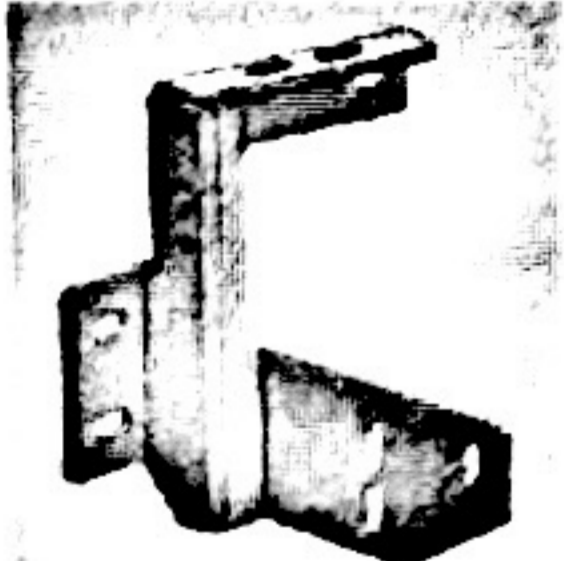

#### Note

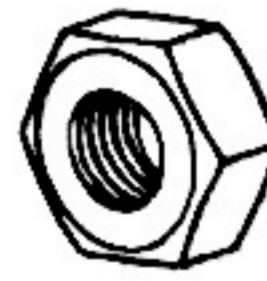
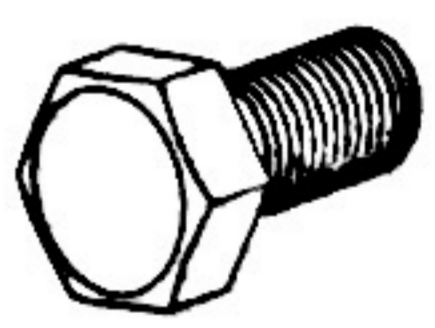
Relevant matters must be obeyed for the smooth installation and use.

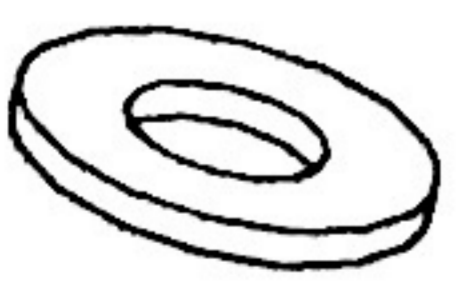
- Non-compliance may cause the problems with vehicle. Please do not install that is not recorded in this instruction.
- Please forgive we are not responsible for any consequences if you install follow your individual subjective thoughts.

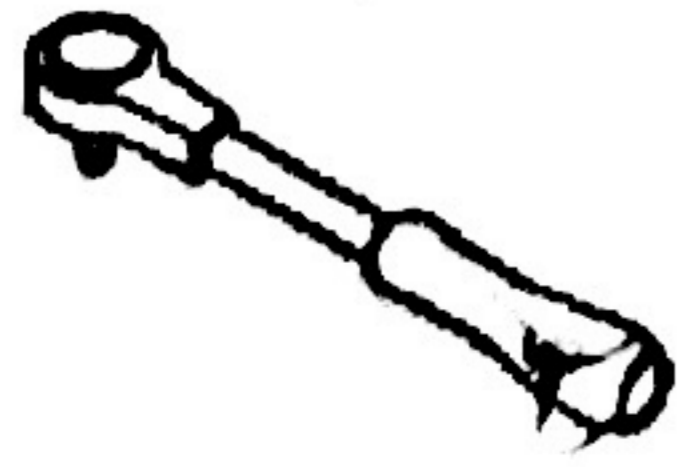
#### Product Composition \*Please confirm if it is missing.

1. Component 1 (Left and Right) 	2. Support Bracket (Left and Right) 	3. Spring cable (2 piece) 	4. M10 T-Bolts (2 piece) 	5. M10 flange nut (12 piece) 	6. M10x30 hex Bolts (10 piece) 
7. M10 Lock washer (12 piece) 	8. M10 flat washer (22 piece) 				
Ratchet 	Torque wrench 	socket 	plum wrench 		

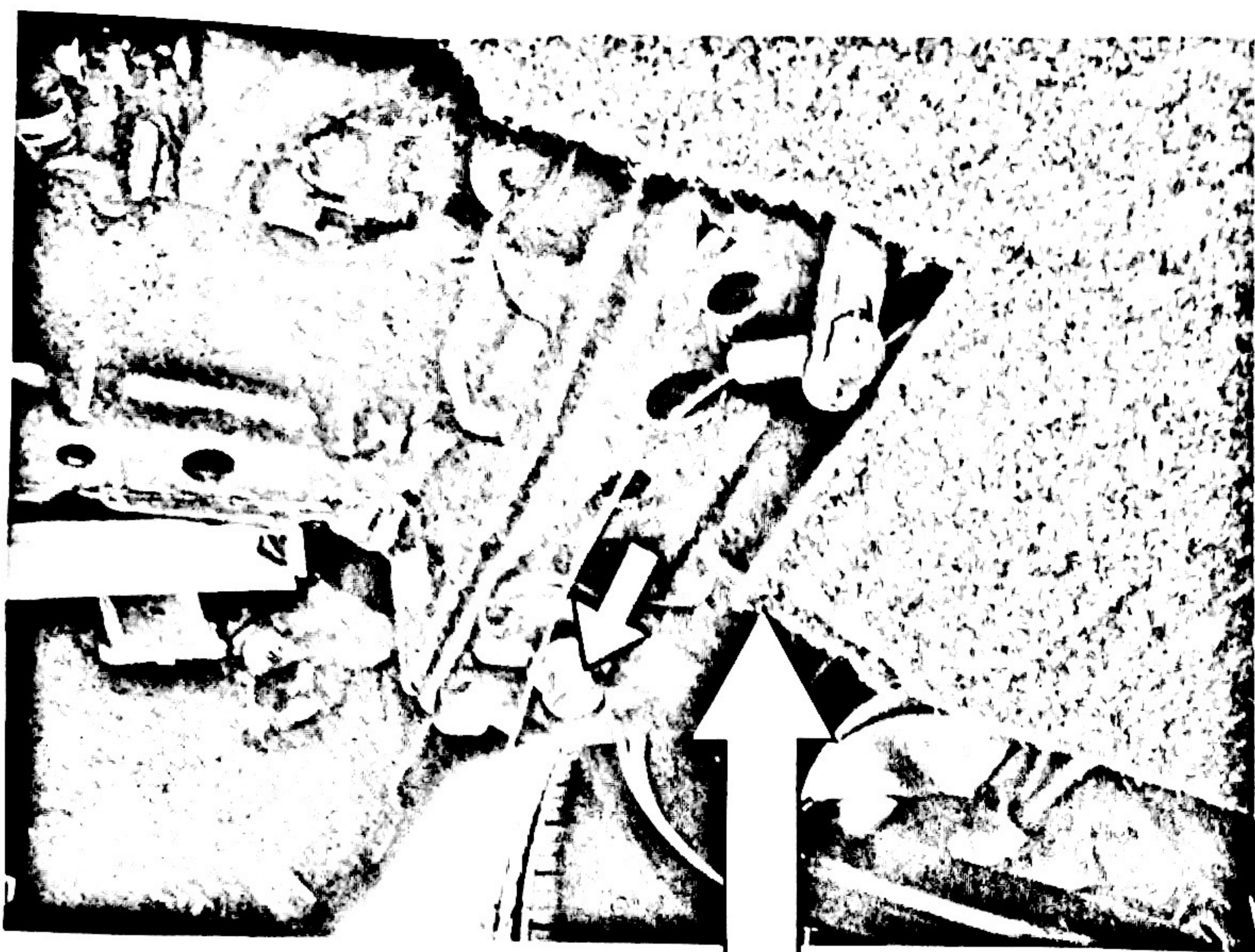

Insert the U-bent end of the Fish Wire into the large hole and out the outer smaller hole. Pull the Fish Wire with Bolt Plate into and through the hole in the crossmember. **NOTE:** Bolt Plate as pictured must be rotated 180 degrees to fit into hole (Figure 5).

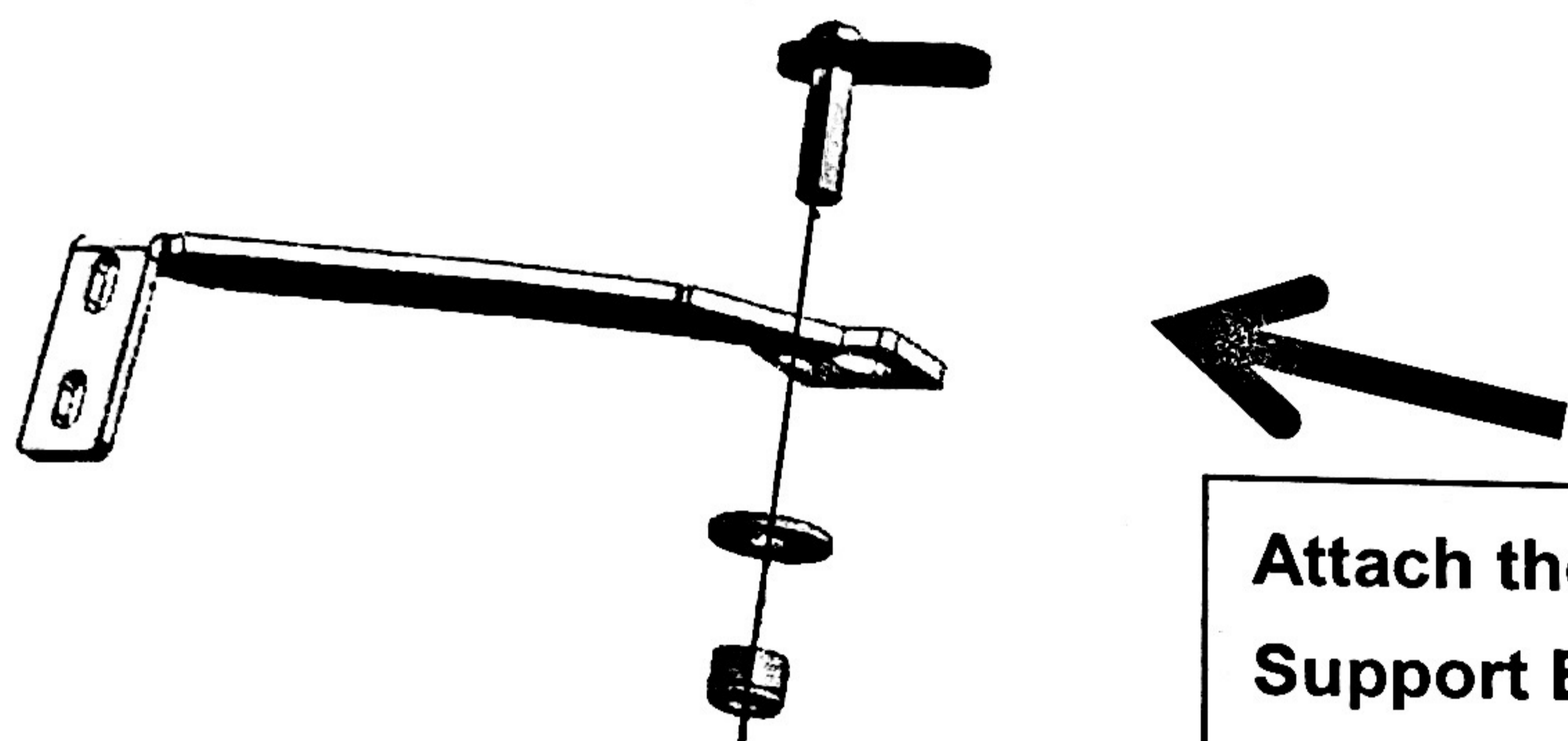

Attach the Passenger/Right Support Bracket to the M10 T-Bolt (M10 T-Bolt, M10 Lock Washer, Flat washer, M10 Nut)

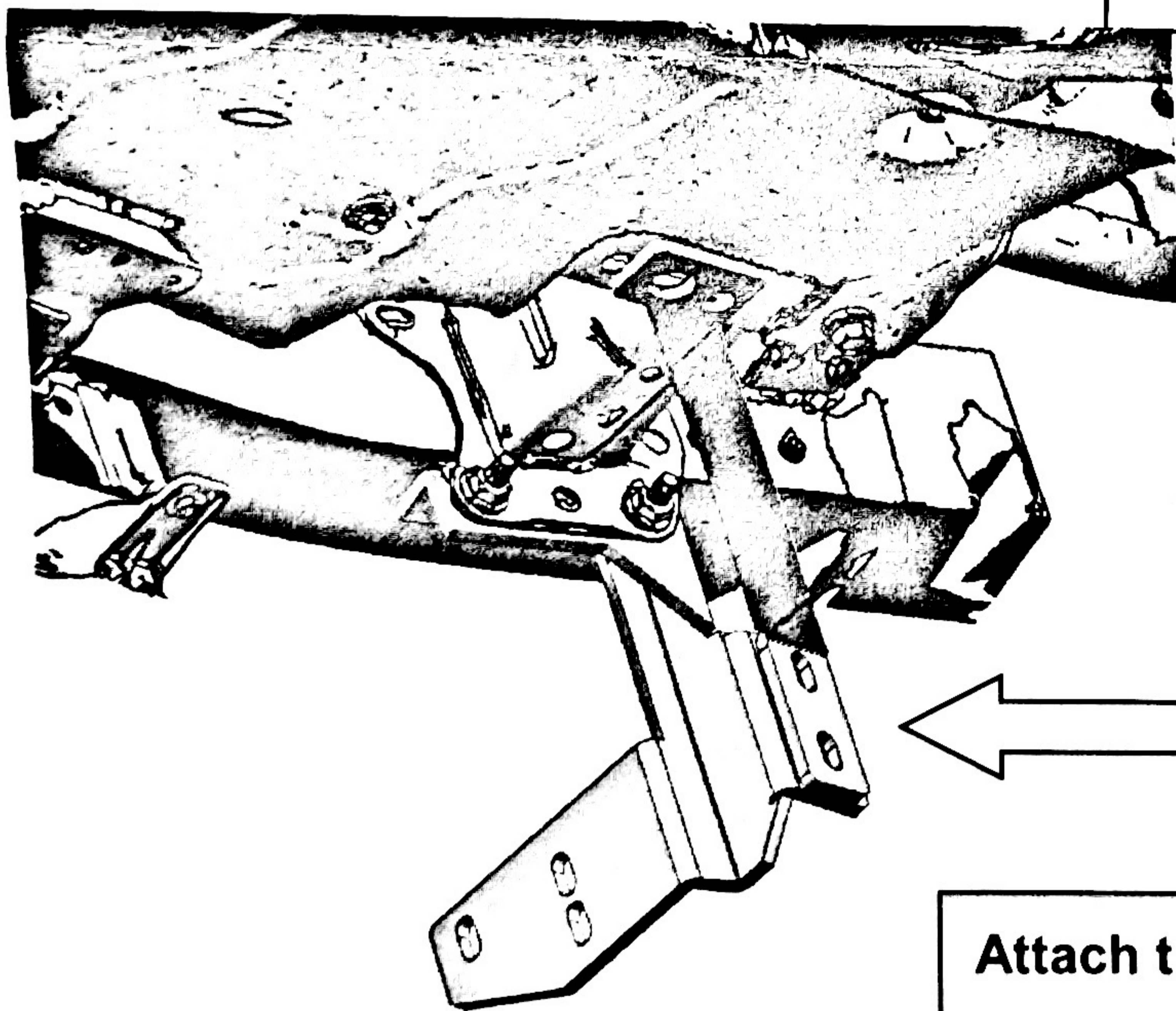

M10\*30 Hex Bolt  
M10 Lock Washer  
M10 Flat Washer  
M10 Nut

Attach the Passenger/Right Support Bracket to the back of the Mounting Bracket

**TIPS**

= **Routine Maintenance** =

- 1) Please use neutral detergent to wet the soft cloth or suede and so on, then clean our product

**Note**

- Do not use any hard objects such as brushes. Otherwise, it will cause surface scratches.
- Please protect the product from gasoline, light fuel, fuel oil, brake fuel, engine oil, paint thinner, sulphuric acid (battery liquid), wax remover, etc. Otherwise, it will cause product discoloration and dyeing. In case product come into contact with above objects, please use neutral detergent to wet the soft cloth or suede and so on, then clean our product and wash it with water quickly.

● **WAttentions**

- The labels of fitting procedure inside the thick wireframe is particularly important. Pay attention to them in the actual installation.
- Pay attention to safety during installation.

**Fitting Procedure**

1. Start installation under the Passenger/Right front of the vehicle. Locate the end of the frame and impact bumper just behind the outer bumper cover. Temporarily remove the factory bolts and "L" bent bracket, **(Figure 1)**. **NOTE:** Bracket will not be reinstalled.
2. Select the Passenger/Right Frame Mounting Bracket. Reuse the factory bolts to attach the Mounting Bracket to the frame and bottom of the impact bumper, **(Figure 2)**. Do not fully tighten hardware at this time.

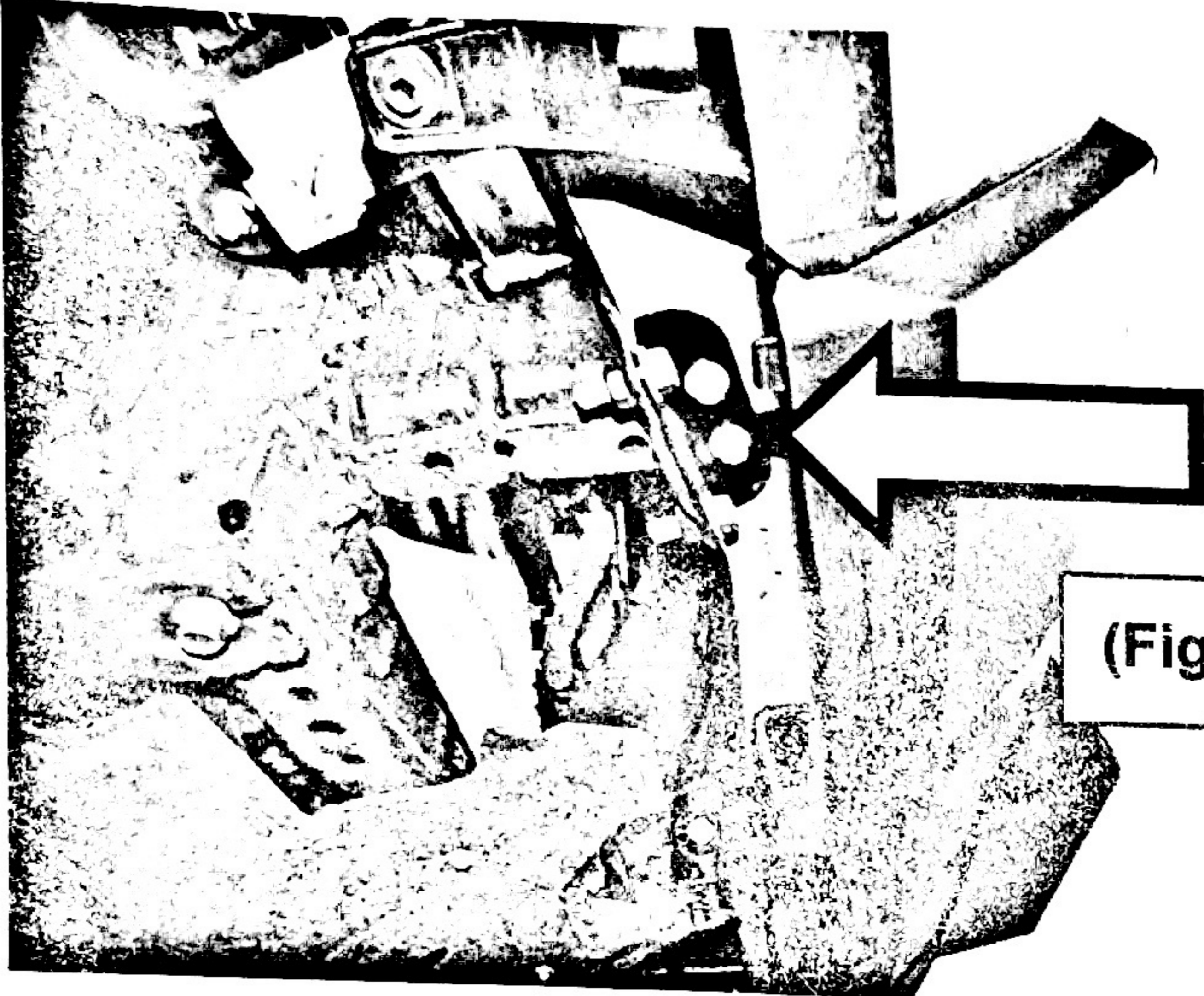

**(Figure 1)**

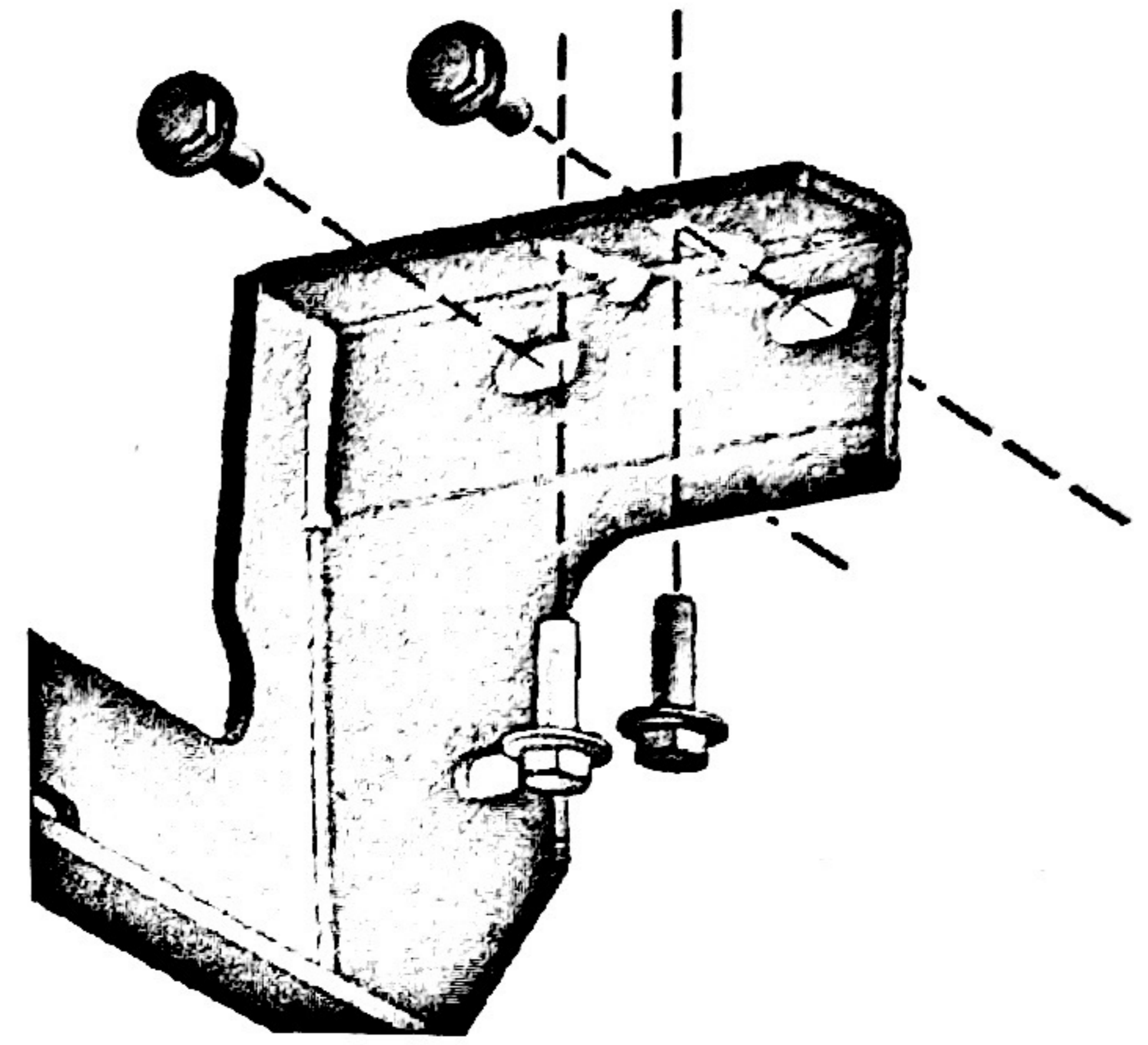

**Reuse the factory hardware to attach the Passenger/Right Mounting Bracket to the frame and inner impact bumper(Figure 2)**

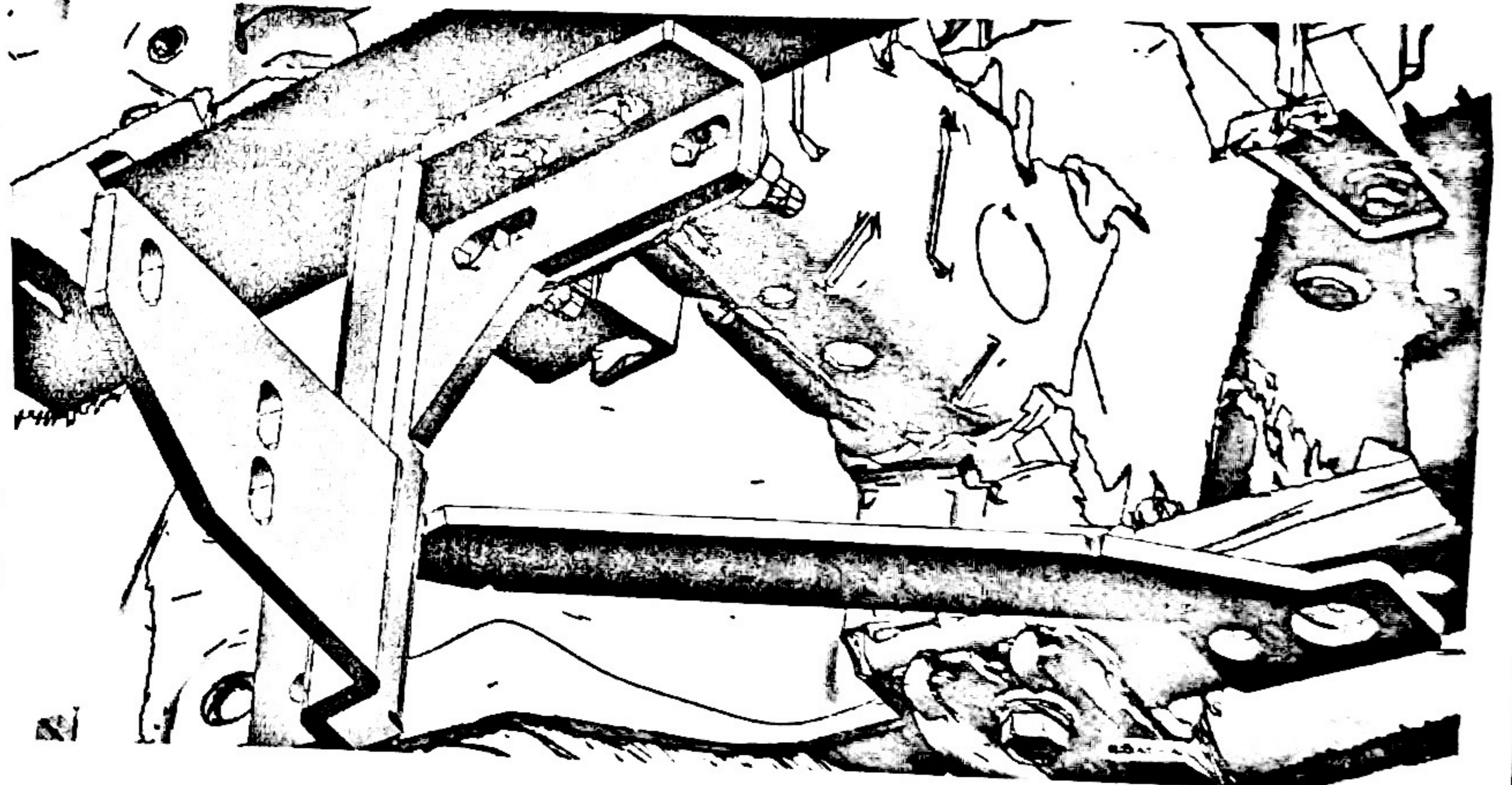

3. Select (1) 10mm Bolt Plate and (1) 10mm Fish Wire. Thread the Fish Wire onto the Bolt Plate, **(Figure 4)**. Bend the straight end of the Fish Wire into a hook, Insert the bent end of the Fish Wire into the large hole in the bottom of the frame crossmember, **(Figure 5)**.

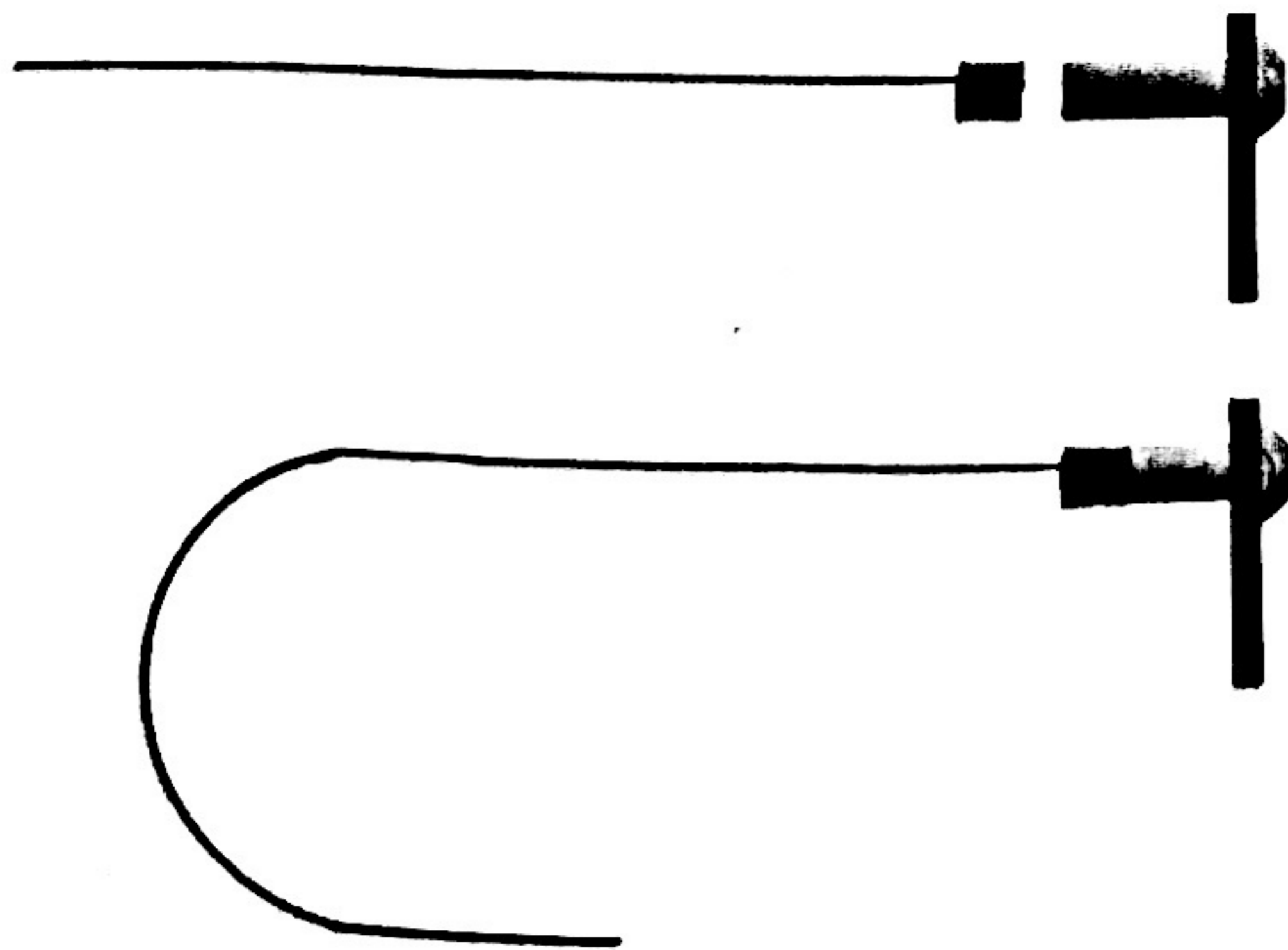

**Thread (1) 10mm Fish Wire onto (1) 10mm Bolt Plate. Bend the straight end of the Fish Wire into a "U (Figure 4).**