



2399B

Installation Instruction

Thank you very much for choosing our products.











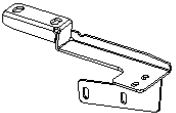

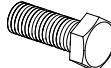

Please read the installation instruction carefully before using our product and be sure to fully understand the contents mentioned above for subsequent installation.

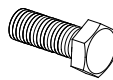



In addition, please keep properly the installation instruction for product maintenance in future.

Attention

- The following symbols are used in this installation instruction.
- Non-compliance may cause the problems with vehicle. Please do not install that is not recorded in this instruction.
- Please forgive that we are not responsible for any consequences arising from the installation not according to our installation instruction.

● **Product Composition** *Please confirm if it is missing.

1. Mount Bracket 1 (2 pieces L/R) 	2. Mount Bracket 2 (2 pieces L/R) 	3. Hex bolts M12X30 (4 pieces) 	4. M12 Flat Washer (8 pieces) 	5. M12 Lock Washers (4 pieces) 
6. M12 Hex Nut (4 pieces) 	7. Hex bolts M10X30 (2 pieces) 	8. M10 Flat Washer (4 pieces) 	9. M10 Lock Washers (2 pieces) 	10. M10 Hex Nut (2 pieces) 
11. Hex bolts M18X30 (4 pieces) 	12. M8 Flat Washer (8 pieces) 	13. M8 Lock Washers (4 pieces) 	14. M8 Hex Nut (4 pieces) 	

Ratchet 	Torque wrench 	socket 	plum wrench 
--	--	---	--

● **Installation tools** *Please prepare these tools before installation.

● **Attentions**

- The labels of fitting procedure inside the thick wireframe is particularly important. Pay attention to them in the actual installation.
- Pay attention to safety during installation.

Fitting Procedure

Installation Instruction

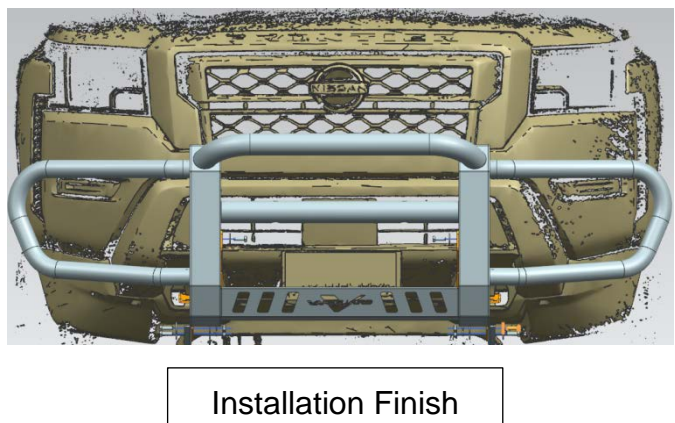
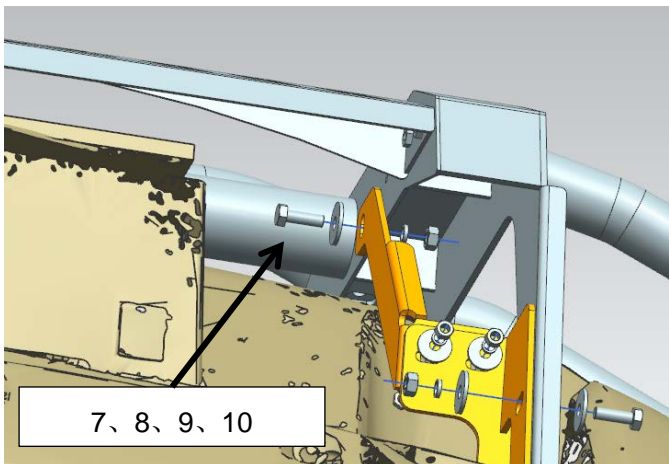
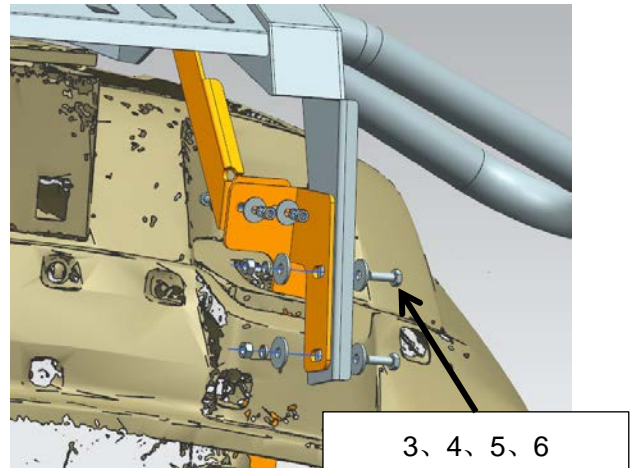
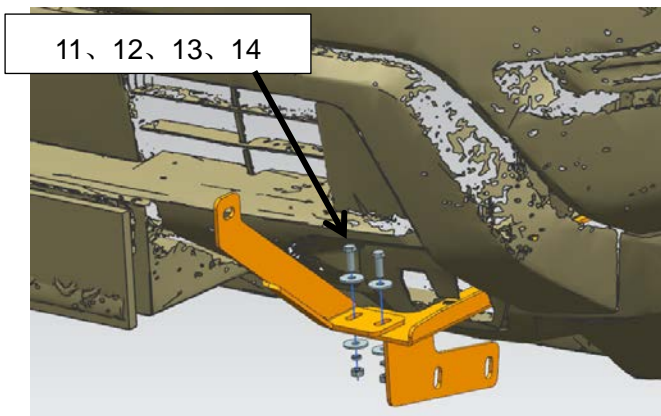
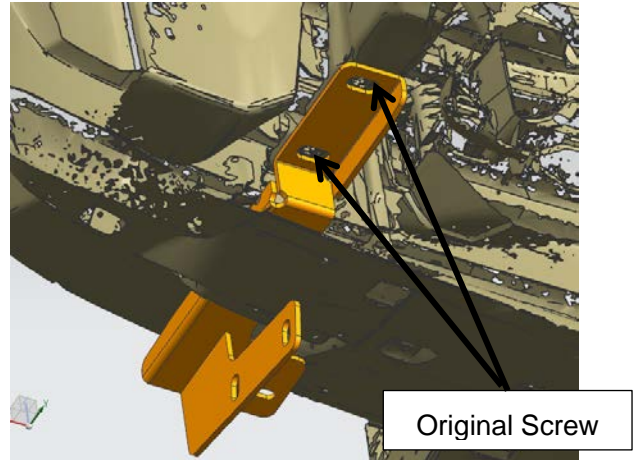
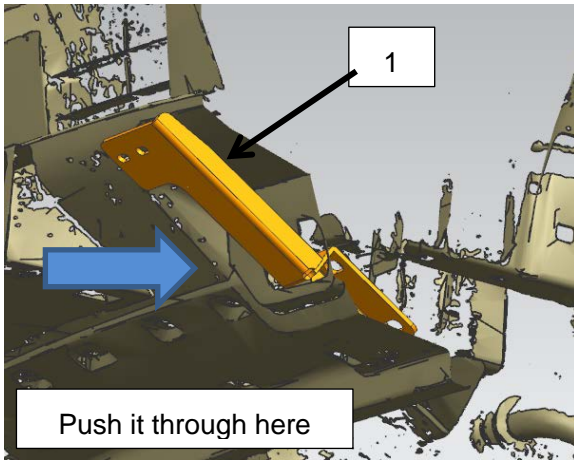

TIPS:

= Routine Maintenance =

Do not attach the bar to the vehicle using anchorages not intended for this purpose.

Do not use the bar for any vehicle other than those specified by the bar manufacturer.

The use of an alloy polish such as 'Auto Sol' is recommended for extra shine, however hot soapy water will also clean well.

Please use neutral detergent to wet the soft cloth or suede and so on, then clean our product.