

**INSTALLATION INSTRUCTION
PART NO.: 1271 BRACKETS
FOR MAZDA CX-5**













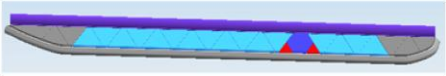
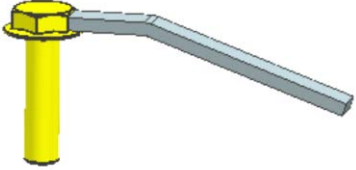
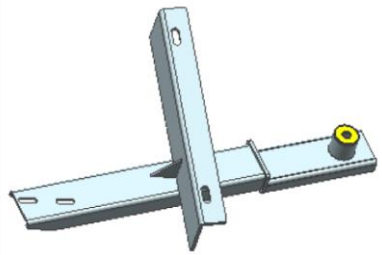

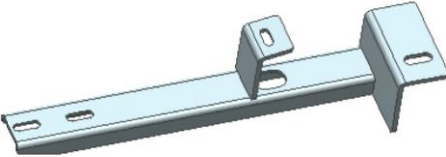
NOTICE:

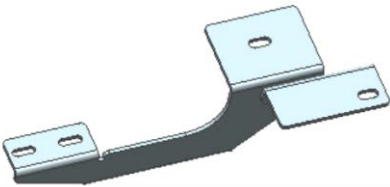
- ≡ Please read the instruction completely for easy installation, which will also help you to avoid scratches or other potential damages to your appealing car.
- ≡ Please periodically check and retighten all the hardware and clean the investment for a refresh look.

FUNCTIONS AND FEATURES

- ≡ Bracket is with a rational design of its structure making it a firm installation. Preservative treatment is done on surface providing a better corrosion resistance.
- ≡ Customer-friendly design leads to an easy mounting which relies on vehicle's body holes sites instead of drilling holes.

PART LIST

NO.	QTY	FIGURE	NO.	QTY	FIGURE
①	2	 Body of running board	⑧	2	 Special bolt
②	2	 Front bracket	⑨	6	 Hex nut M8
③	2	 Center bracket	⑩	4	 Large size washer D8
④	2	 Rear bracket	⑪	6	 Spring washer D8
⑤	4	 T shape bolt M8	⑫	2	 X-large washer D8
⑥	4	 M8 PVC Plastic card	⑬	8	 Spring washer D6
⑦	8	 Large size washer D6	⑭	8	 Hex bolt M6x25

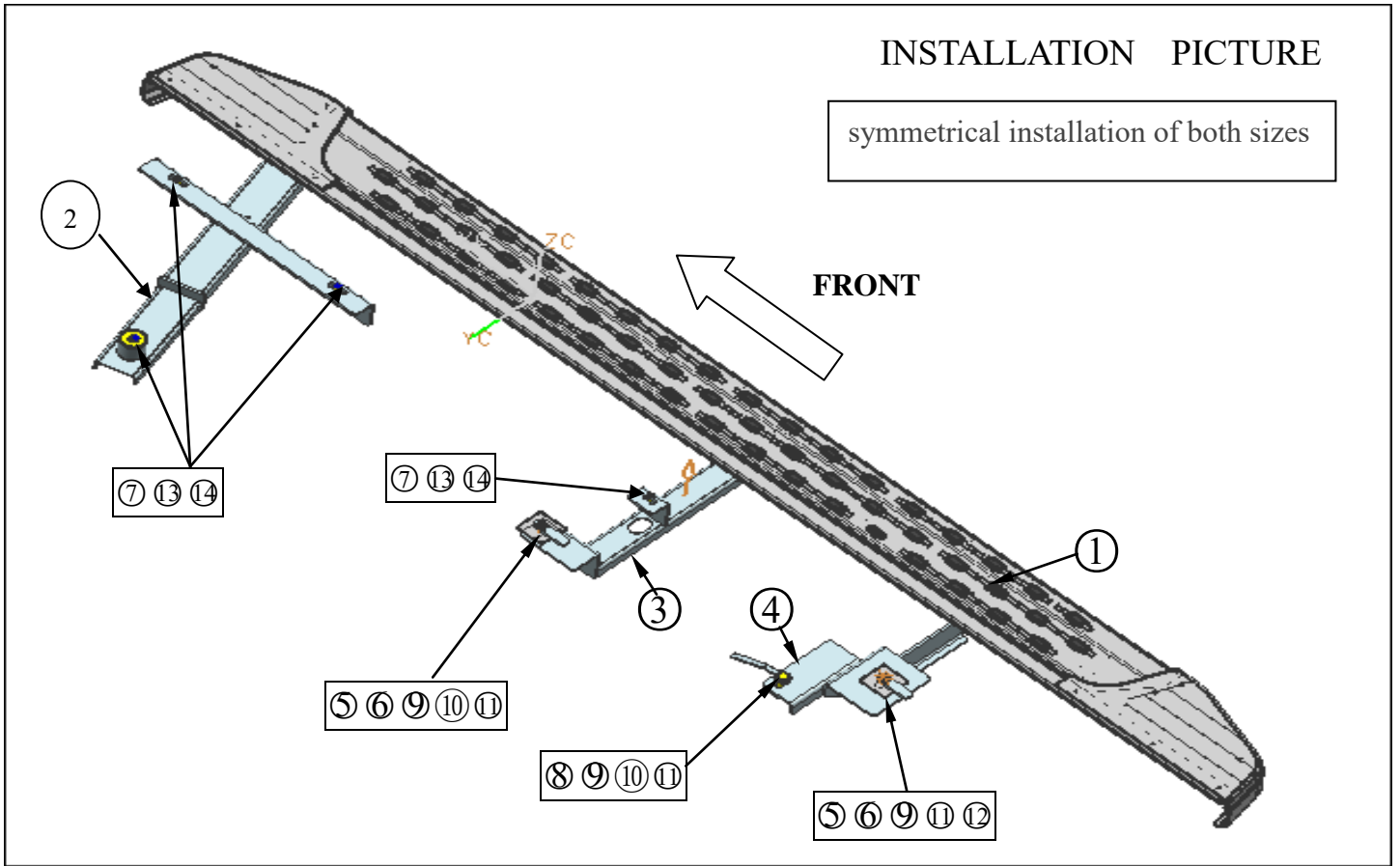

INSTALLATION STEPS;

STEP 1: Install front bracket;

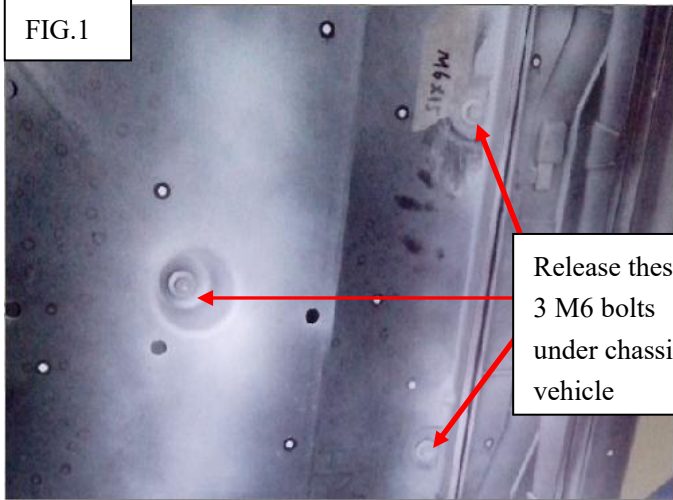

(1) Release these 3 M6 bolts under chassis of vehicle



- (2) Turn over the preventer plate and connect the brackets inward the skid plate, do not tighten the bolts.



STEP 2: Install centre brackets;



- (1) As FIG.4 shows, remove the preventer plate under the vehicle.

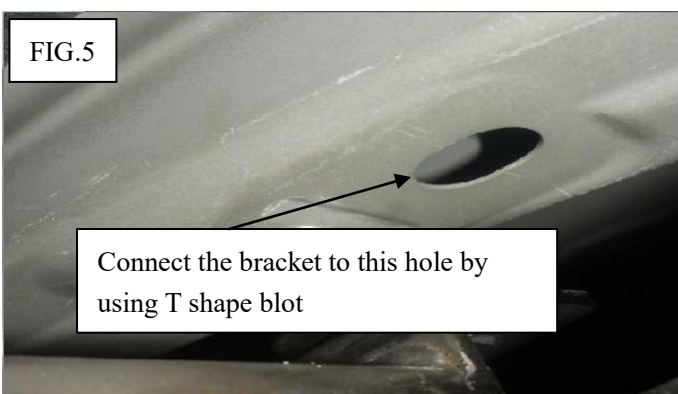

- (2) Connect the bracket vehicle by using M6 tapped hole under the chassis,

STEP3: Install centre brackets;

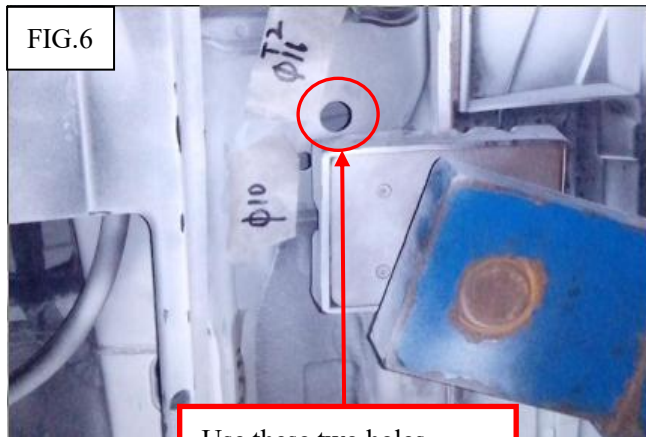

Use these two holes

Connect the rear bracket under the chassis by using the hole showed on FIG.6 with ⑤ T shape bolt.

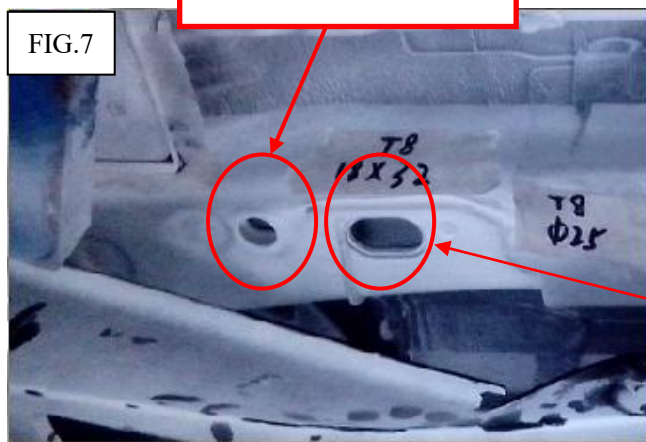

Connect the rear bracket under the chassis by using the hole showed on FIG.7 with ⑧ special bolt.

push the special bolt inside through this hole



View of completed installation

STEP 4. Connect the running board onto the brackets and adjust it to a proper location. Notice that the running board should be parallel to the body of vehicle. Tighten the bolt while adjust them to the best location.

STEP 5. Install the running board of the other side in same way as above.

STEP 6. Cut the skid plate.

FIG.9

Move the preventer plate back to chassis after tighten all the bolts, cut off those area marked in white where would impede the installation.

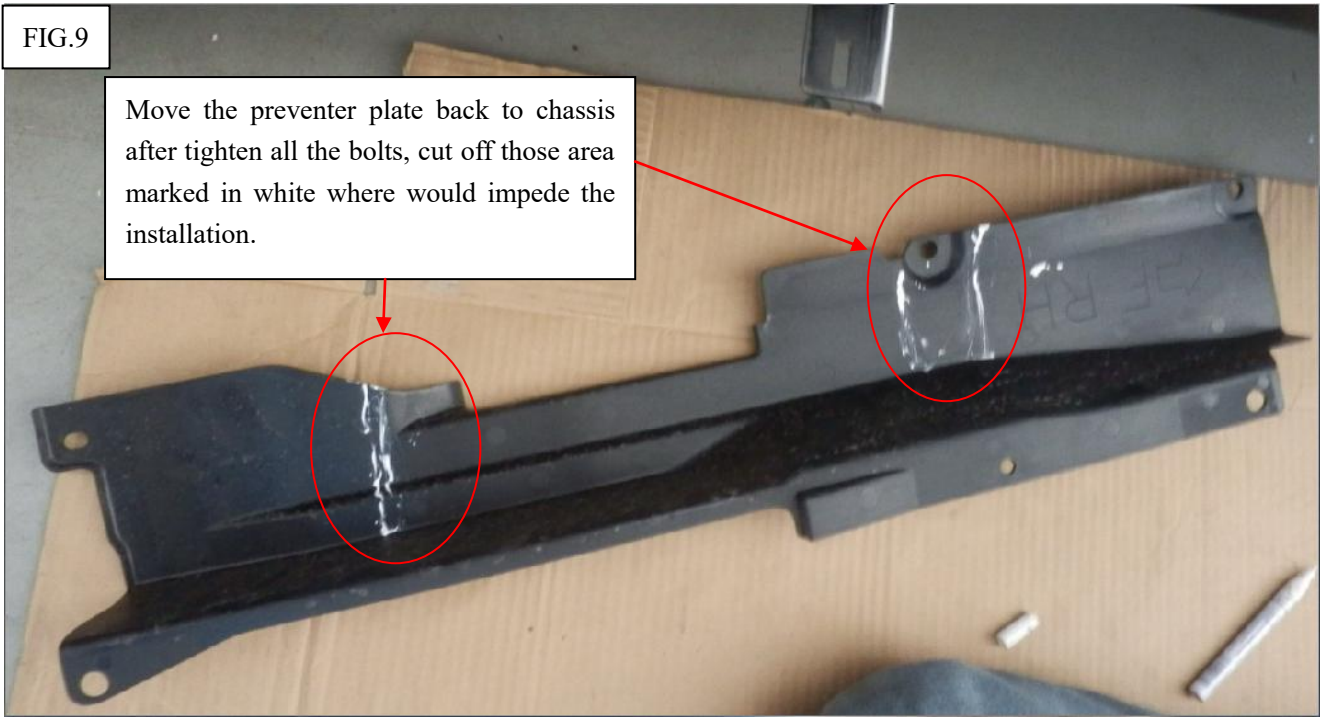

STEP 7: Check if there are bolts neglected and make sure all the bolts are tightened. Thus, installation completes.

FIG. 10

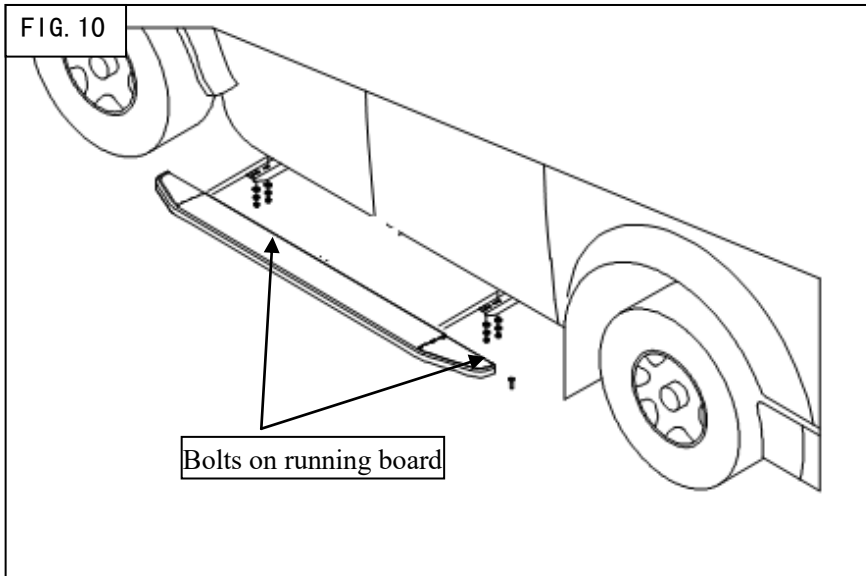

DISCLAIMER: We are not responsible for any quality problems caused by improper installation and use.