

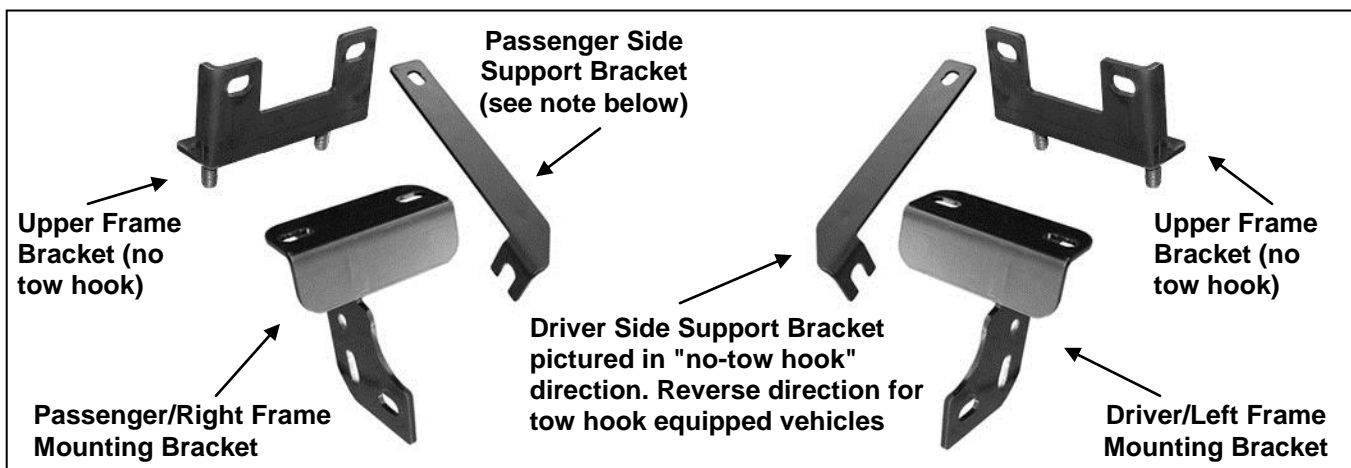

PARTS LIST:

Qty	Description	Qty	Description
1	Bull Bar	10	12mm Lock Washers
2	Upper Frame Brackets (for trucks without tow hooks only)	8	12-1.75mm Hex Nuts
1	Driver/Left Frame Mounting Bracket	2	10-1.5mm x 35mm Hex Bolts
1	Passenger/Right Frame Mounting Bracket	2	10mm Lock Washers
1	Driver/Left Support Bracket	4	10mm x 30mm OD x 2.5mm Flat Washers
1	Passenger/Right Support Bracket	2	10-1.5mm Hex Nuts
2	12-1.5mm x 30mm Special Fine Thread Hex Bolt (for trucks without tow hooks only)	2	5-.8mm x 15mm Button Head Allen Bolt
4	12-1.75mm x 35mm Hex Bolts	4	5mm x 10mm OD x 1mm Flat Washers
14	12mm x 32mm OD x 3mm Flat Washers	2	5mm Nylon Lock Nuts
		1	Wrench (allen bolt)



PROCEDURE:

- 1. REMOVE CONTENTS FROM BOX. VERIFY ALL PARTS ARE PRESENT. READ INSTRUCTIONS CAREFULLY BEFORE STARTING INSTALLATION. CUTTING IS REQUIRED. ASSISTANCE IS RECOMMENDED.**
- Starting at the underside of the front bumper, carefully remove the plastic splash guard. **NOTE:** Depending on the model of truck, the splash guard may be attached to the bottom of the truck with hex bolts and several two-piece plastic push-in clips, **(Figure 1A)**. Remove all hex bolts then locate the clips behind the bumper cover. Pry up on the center pin of the clip with a small flat blade screwdriver and remove the entire clip, **(Figure 1B)**. Pay close attention to the type and location of all factory hardware for reinstallation. The splash guard may also be attached to the bumper cover with rivets at the corners. Use wire cutters to remove the rivets. Once all fasteners have been removed, move splash guard to a clean stable work area.
- Next, determine if the truck is equipped with tow hooks.

For models without tow hooks:

- Remove the hex nuts from the two lower factory bumper bolts, **(Figure 2)**.
- Select (1) Upper Frame Bracket, (will fit left or right-without tow hooks only), and the driver side Mounting Bracket, **(Figure 3)**. Bolt the two Brackets together with (2) 12mm Flat Washers, (2) 12mm Lock Washers and (2) 12mm Hex Nuts, **(Figure 4)**. Do not tighten at this time.
- Insert the assembled Mounting Bracket up from behind the bumper and align the holes in the Mounting Bracket with the bumper bolts. Attach the Bracket to the bumper bolts using the factory hex nuts and snug but do not tighten the hardware, **(Figure 4)**.

NOTE: On some vehicles, it may be easier to assemble the two-piece bracket on the vehicle. Install the Upper Frame Bracket first, then bolt the Mounting Bracket to the bottom as previously described.

**VGUBG-1074-0954BK-LED BULL BAR
09-13 DODGE RAM 1500**

- d. Install the driver side Lower Support Bracket with the bent end toward the front of the vehicle, **(Figures 3 & 4)**. Bolt the Support Bracket to the inside of the Lower Mount using the top round hole in the Lower Mounting Bracket with the included (1) 10mm x 35mm Hex Bolt, (2) 10mm Flat Washers, (1) 10mm Lock Washer and (1) 10mm Hex Nut.
- e. Attach the flat end of the driver side Bracket to the frame with (1) 12-1.5mm x 30mm **Special Fine Thread** Hex Bolt, (1) 12mm Flat Washer and (1) 12mm Lock Washer, **(Figure 4)**. **IMPORTANT:** The hole in the bottom of the frame is **fine thread**. Only use the 12-1.5mm x 30mm Hex Bolt provided in the hardware kit. Snug but do not tighten all hardware at this time.

For models with tow hooks:

- a. Remove the (2) hex nuts holding the front of the tow hook to the back of the bumper, **(Figure 5)**.
 - b. Select the driver side Lower Mounting Bracket, **(Figure 6)**. Hang the Bracket from the tow hook mounting studs using the factory Hex Nuts. Do not tighten hardware at this time.
 - c. Line up the flat end of the driver side Support Bracket to the inside of the Lower Mounting Bracket. The Support Bracket will use the rear hole for the Bull Bar. Do not attach at this time.
 - d. Attach the bent end of the Support Bracket to the rear tow hook bolt. Loosen the rear mounting bolt for the tow hook. Insert the slotted end under the head of the factory bolt, **(Figure 6)**.
 - e. Snug but do not tighten all hardware at this time.
4. Repeat the appropriate **Step 3** for the passenger side Mounting Bracket installation.
 5. With help, position the Bull Bar on the inside of the Mounting Brackets. Use the included (4) 12-1.75mm x 35mm Hex Bolts, (4) 12mm Lock Washers, (8) 12mm Flat Washers and (4) 12mm Hex Nuts to attach the Bull Bar to the Mounting Brackets, **(Figure 7)**. **NOTE:** On vehicles with tow hooks, insert the rear bolt through the tab on the Bull Bar, the Mounting Bracket and through the flat end of the Support Bracket. Snug but do not tighten hardware.
 6. Stand back from the vehicle and check to see that the Bull Bar is centered and level on the vehicle and adjust as necessary. Tighten only the hardware securing the Mounting Brackets to the truck. Do not tighten the hardware on the Bull Bar. Remove the Bull Bar.
 7. Next, hold the splash guard up to the bumper cover and align it with the mounting points, **(Figure 8)**. Mark the location of the Mounting Brackets onto the back of the splash guard, **(Figure 9)**. Cut an approximately 1/2" wide by 4" long slot in the splash guard as pictured in **Figure 10**. **NOTE:** The size of the slot is an estimate only and may vary due to different factory designs for the splash guards and front bumper covers. Also, additional cutting may be required to clear the Support Bracket on vehicles equipped with tow hooks. **IMPORTANT:** To maintain the integrity of the splash guard, do not cut the slot any larger than necessary. Do not cut through the front or back edges of the cover, **(Figure 10)**. Make several small cuts first and check the fit often for a clean installation.
 8. Check the fit and reinstall the splash guard using the factory hardware. Use the included (2) 5mm x 15mm Allen Bolts, (4) 5mm Flat Washers and (2) 5mm Lock Nuts to replace the rivets if required, **(Figure 11)**.
 9. Reinstall the Bull Bar described in **Step 5**, **(Figure 7)**.
 10. Level and adjust the Bull Bar and tighten all hardware.
 11. Do periodic inspections to the installation to make sure that all hardware is secure and tight.

To protect your investment, wax this product after installing. Regular waxing is recommended to add a protective layer over the finish. Do not use any type of polish or wax that may contain abrasives that could damage the finish.

For stainless steel: Aluminum polish may be used to polish small scratches and scuffs on the finish. Mild soap may be used also to clean the Bull Bar.

For gloss black finishes: Mild soap may be used to clean the Bull Bar.

Driver Side Installation Pictured

Pry up the center pin to remove the complete fastener

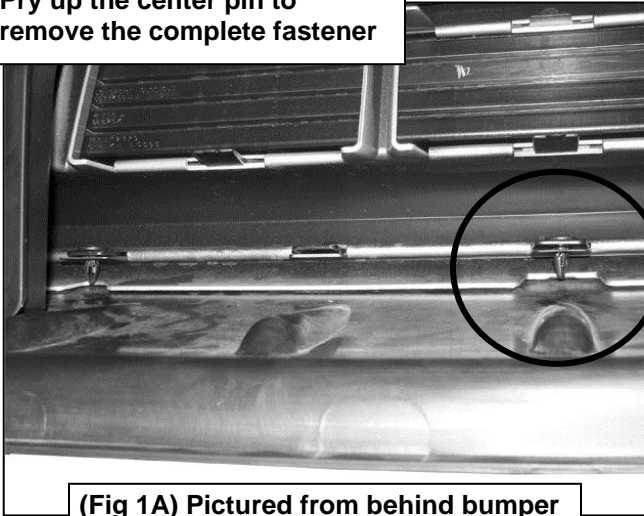

(Fig 1A) Pictured from behind bumper

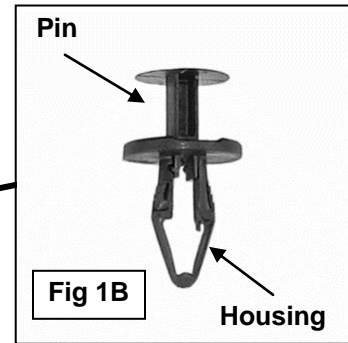
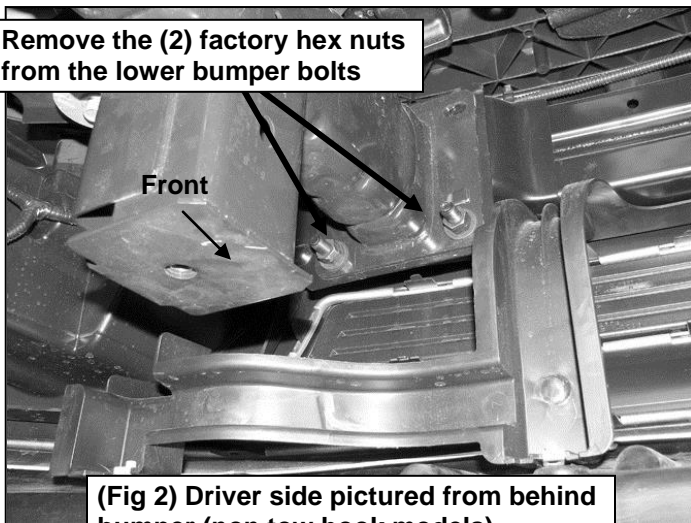
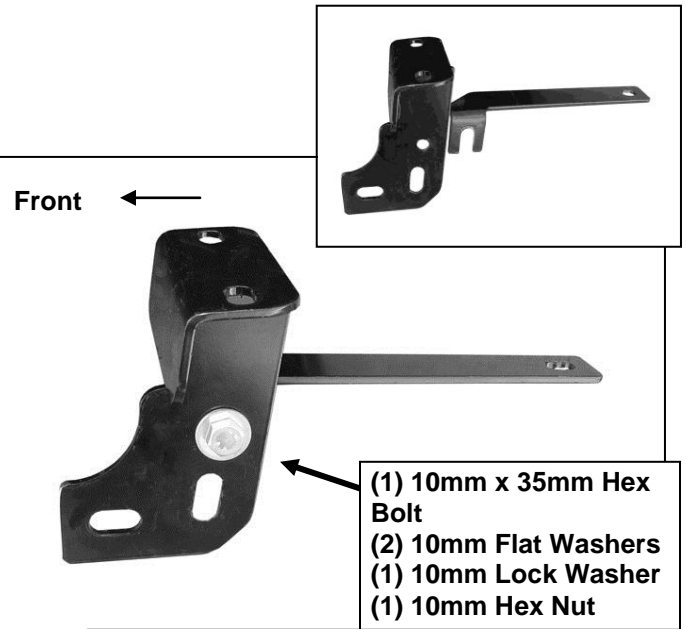

Fig 1B

Remove the (2) factory hex nuts from the lower bumper bolts



(Fig 2) Driver side pictured from behind bumper (non tow hook models)



(Fig 3) Driver side Support Bracket in "no Tow Hook" position

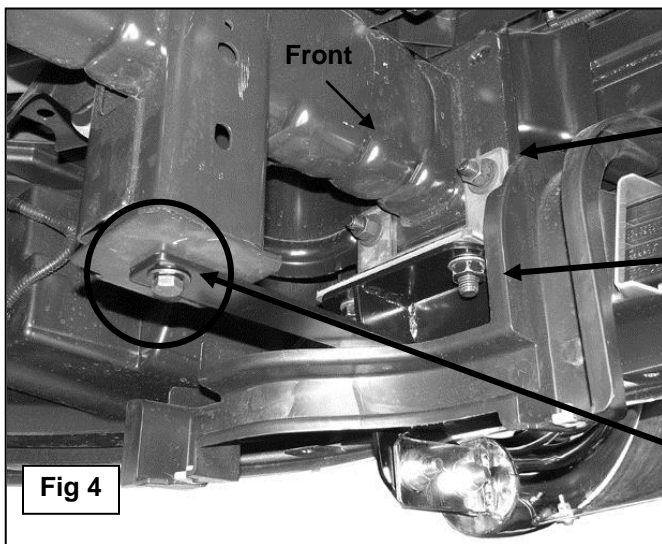

Fig 4

Frame Mounting Bracket
"No Tow Hook Models,"
use factory hex nuts

Driver side Mounting
Bracket requires:
(2) 12mm Flat Washers
(2) 12mm Lock Washers
(2) 12mm Hex Nuts

IMPORTANT: On models without tow
hooks, use only the supplied
12-1.5mm x 30mm Fine Thread Hex Bolt
12mm Flat Washer
12mm Lock Washer

Driver Side Installation Pictured

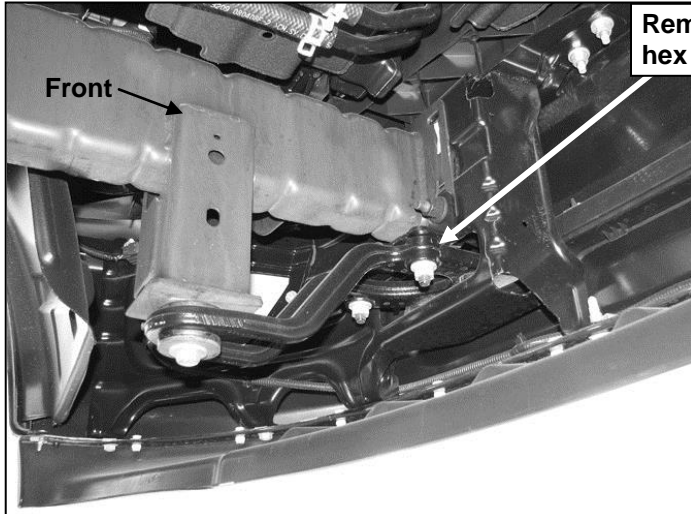

Remove the (2) factory hex nuts from tow hook

(Fig 5) Driver side mounting location pictured from behind bumper on tow hook equipped model

- 12mm x 35mm Hex Bolt
- (2) 12mm Flat Washers
- 12mm Lock Washers
- 12mm Hex Nuts
- (also bolts the Bull Bar to the Mounting Bracket)

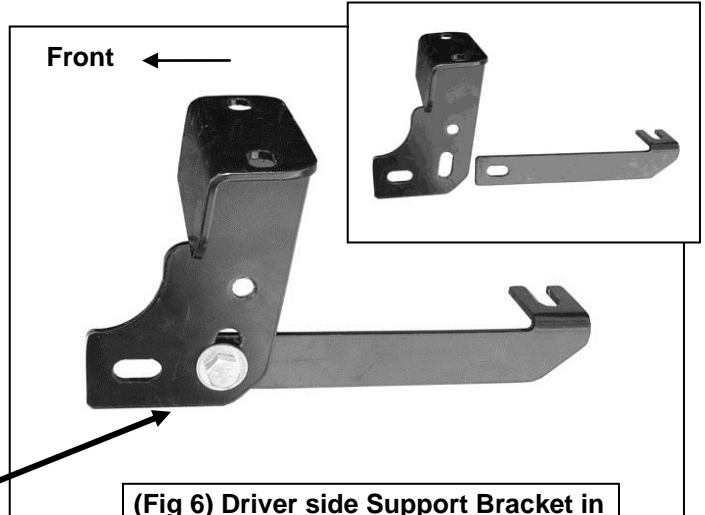

(Fig 6) Driver side Support Bracket in "with Tow Hook" position

Installation pictured without the splash guard for illustration

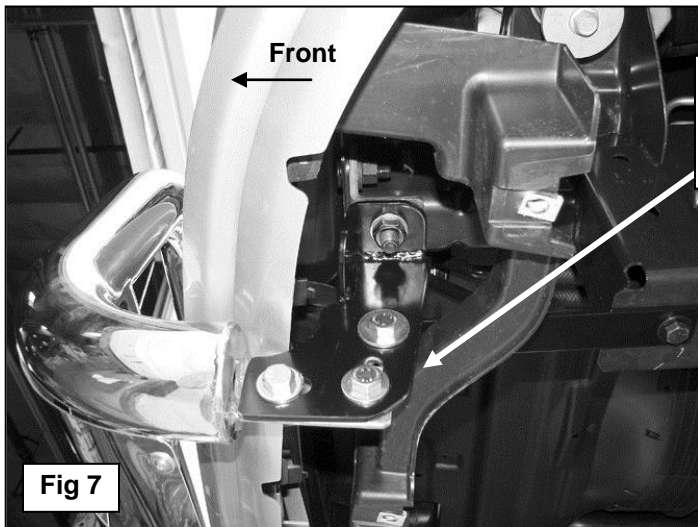

- (2) 12mm x 35mm Hex Bolts
- (4) 12mm Flat Washers
- (2) 12mm Lock Washers
- (2) 12mm Hex Nuts

Fig 7

Hold the splash guard up to the brackets and mark location for cutting to clear brackets. Cut only what is needed to insert bracket through the splash guard.

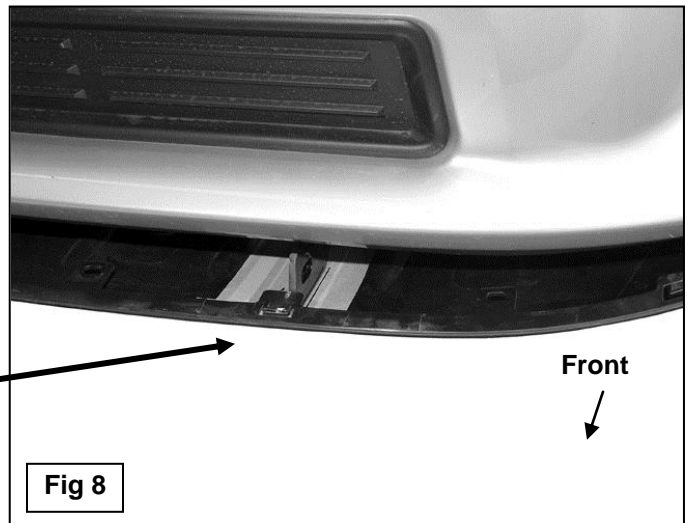
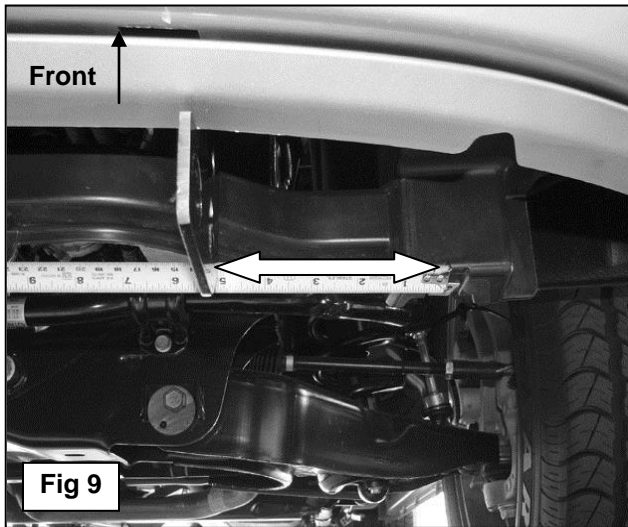

Fig 8

Driver Side Installation Pictured



Measure the distance from the mounting point for the splash guard to the bracket on the driver and passenger side. Use this measurement as a reference point to check location before cutting the 1/2" wide x 4" long slot

Cut only what is needed to insert bracket through the splash guard. Do not cut through the front edge of the splash guard

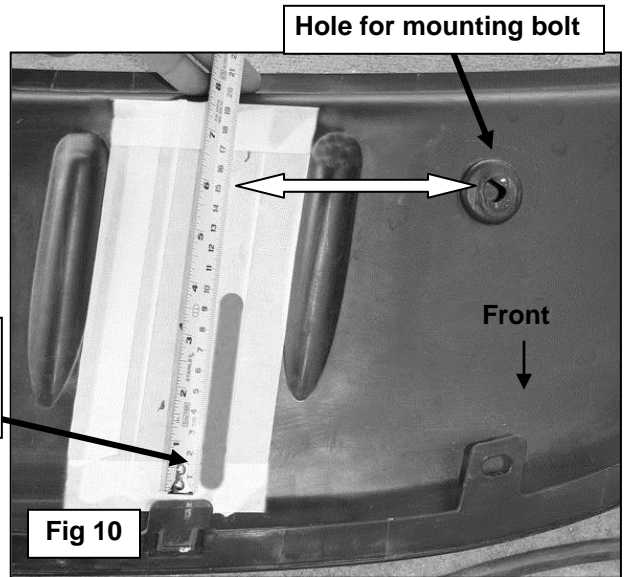

Installation pictured without the splash guard for illustration

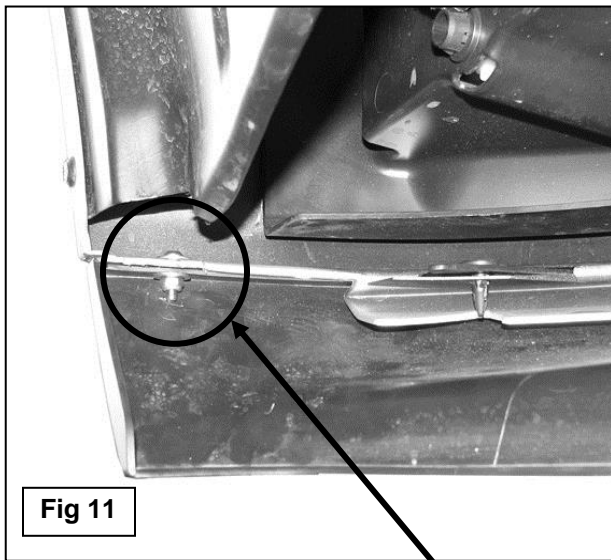

If required, replace the rivet at the corner of the splash guard with the supplied:
5mm x 15mm Button Head Allen Bolt
(2) 5mm Flat Washers
5mm Nylon Lock Nut

