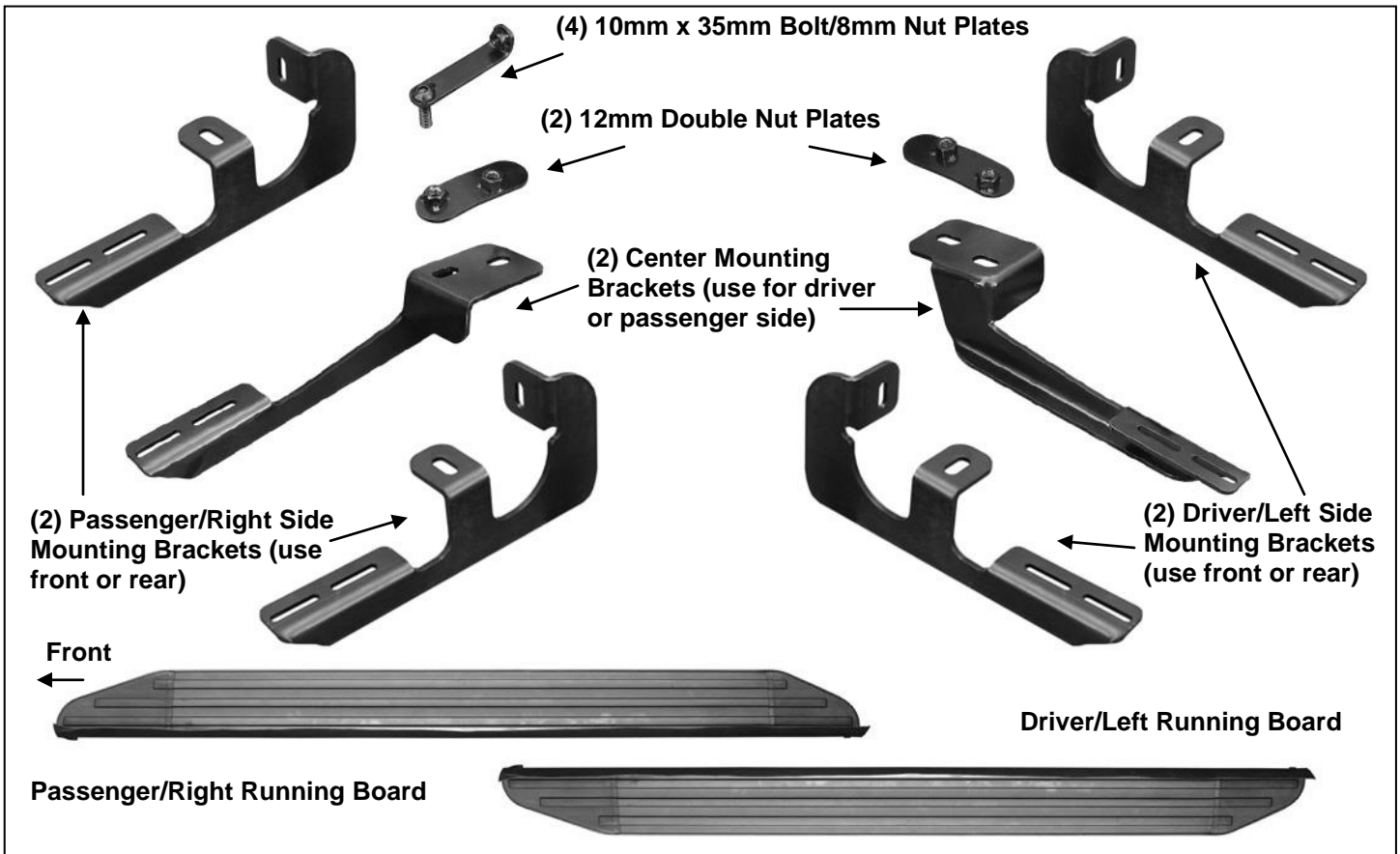

**PARTS LIST:**

Qty	Description	Qty	Description
1	Driver/Left Running Board	8	10mm Lock Washers
1	Passenger/Right Running Board	4	10-1.5mm Hex Nuts
2	Driver/Left Mounting Brackets (front & rear same)	4	8-1.25mm x 30mm Hex Bolts
2	Passenger/Right Mounting Brackets (front & rear same)	4	8mm x 22mm OD x 2mm Flat Washers
2	Center Mounting Brackets (driver & pass same)	4	8mm Lock Washers
2	10-1.50mm Double Nut Plates	12	6-1.0mm x 20mm T-Bolts
4	10mm x 35mm L-Bolt/8mm Nut Plates	12	6mm x 22mm OD x 2mm Flat Washers
4	10mm Plastic Retainers	12	6mm Lock Washers
4	10-1.50mm x 35mm Hex Bolts	12	6-1.0mm Hex Nuts
8	10mm x 27mm OD x 3mm Flat Washers		

**PROCEDURE:**

- 1. REMOVE CONTENTS FROM BOX. VERIFY ALL PARTS ARE PRESENT. READ INSTRUCTIONS CAREFULLY BEFORE STARTING INSTALLATION.**
- Start installation on the driver side. Locate the factory holes in the bottom and inside of the floor panel towards the front tire opening, **(Figure 1)**. **IMPORTANT:** On some vehicles, the body panel may be filled with expanding foam insulation. Use a long flat blade screwdriver or heavy wire, (coat hanger for example), to dig out the foam to provide clearance for the L-Bolt/Nut Plates, **(Figure 2)**.
- Select (1) 10mm L-Bolt/Nut Plate, **(Figure 3A)**. Insert the bent end with the 8mm nut into the hole in the bottom of the floor panel, **(Figure 3B)**. Line up the hex nut with the hole in the side of the floor panel. Thread (1) 10mm Plastic Retainer onto the 10mm Bolt end of the Bolt/Nut Plate, **(Figure 3B)**. **NOTE:** The Plastic Retainer is provided to help hold the Bolt/Nut Plate in position during Bracket installation.

**07-13 CHEVY TRAVERSE/GMC ACADIA/07-10 SATURN OUTLOOK/07-09 BUICK ENCLAVE  
(EXCL. ACADIA DENALI, 2010-13 BUICK ENCLAVE)**

4. Select (1) driver side Mounting Bracket. Position the Bracket up to the vehicle and over the previously installed 10mm Bolt/Nut Plate, **(Figure 4)**. Attach the Bracket to the Bolt/Nut Plate with (1) 10mm Flat Washer, (1) 10mm Lock Washer and (1) 10mm Hex Nut. Attach the Bracket to the 8mm Nut with (1) 8mm x 30mm Hex Bolt, (1) 8mm Lock Washer and (1) 8mm Flat Washer. Do not tighten hardware at this time.
5. Move along the floor panel to the center of the vehicle, **(Figure 5)**. Select (1) 10mm Double Nut Plate, **(Figure 6A)**. Insert the Nut Plate into the large hole in the floor panel reinforcement, **(Figure 6B)**. Line up the threaded hole with the single small hole in the reinforcement, **(Figure 7)**. **NOTE:** The Nut Plate is offset to line up with the offset holes in the floor panel reinforcement.
6. Select (1) Center Bracket. **NOTE:** There is no left or right to the center Bracket, they will fit either side. Line up the (2) holes in the Center Bracket with the Double Nut Plate. Bolt the Bracket to the Double Nut Plate with (2) 10mm Hex Bolts, (2) 10mm Lock Washers and (2) 10mm Flat Washers, **(Figure 8)**. Leave hardware loose at this time.
7. Continue along the floor panel toward the rear of the vehicle. Locate the round hole in the bottom of the floor panel as described in **Step 2, (Figure 9)**. Repeat **Steps 2 – 4** to install the remaining driver side Bracket in the rear location, **(Fig. 10)**.
8. Carefully un-wrap the driver side Running Board. Insert (6) 6mm T-Bolts into the slots in the end of the channels, (3 T-Bolts per channel), on the bottom of the Running Board, **(Fig. 11)**. Hold the Running Board up in approximate position and slide the T-Bolts down to line up with the (3) Mounting Brackets. Tilt the Board up at a slight angle and push back against the vehicle until the T-Bolts fit into the slots in the Brackets. Secure the Running Board to the Brackets with (6) 6mm Flat Washers, (6) 6mm Lock Washers and (6) 6mm Hex Nuts, **(Fig. 12)**. Do not tighten hardware at this time. **NOTE:** The Center Bracket has a little adjustment in and out on the vehicle. Loosen the Bracket and slide the Center Bracket in or outward until it is in about the same position as the front and rear Brackets.
9. Level and adjust the Sidebar properly and tighten all hardware at this time.
10. Repeat **Steps 2 – 9** for passenger side Running Board installation. **IMPORTANT:** The Center Bracket and Double Nut Plate used are the same, driver side and passenger side.
11. Do periodic inspections to the installation to make sure that all hardware is secure and tight.

**To protect your investment**, wax this product after installing. Regular waxing is recommended to add a protective layer over the finish. Do not use any type of polish or wax that may contain abrasives that could damage the finish.

**For stainless steel:** Aluminum polish may be used to polish small scratches and scuffs on the finish. Mild soap may be used also to clean the Running Board.

### Driver Side Installation Pictured

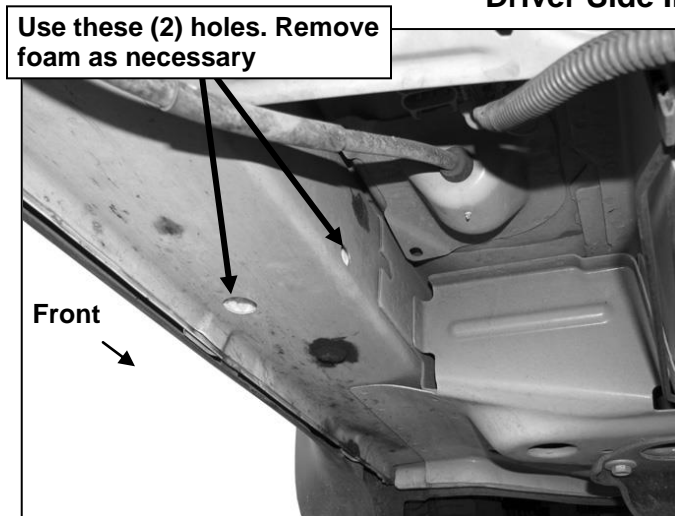

**(Fig 1) Driver side front mounting location**

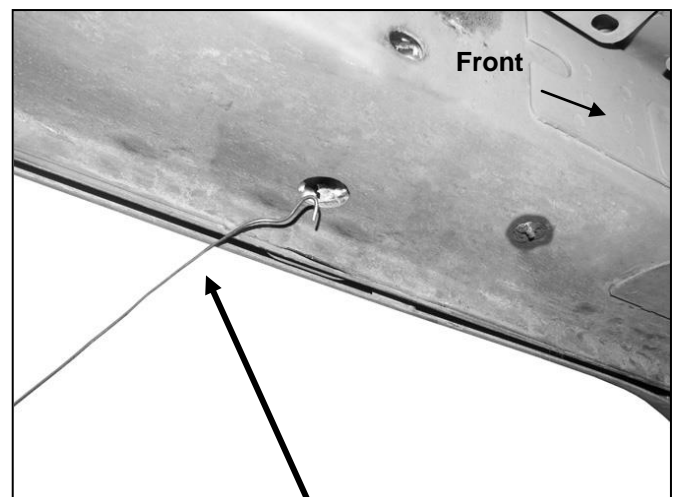

**(Fig 2) Use wire to pull foam from floor panel**

VGSSB-1071-1261AL  
07-13 CHEVY TRAVERSE/GMC ACADIA/07-10 SATURN OUTLOOK/07-09 BUICK ENCLAVE  
(EXCL. ACADIA DENALI, 2010-13 BUICK ENCLAVE)  
Driver Side Installation Pictured

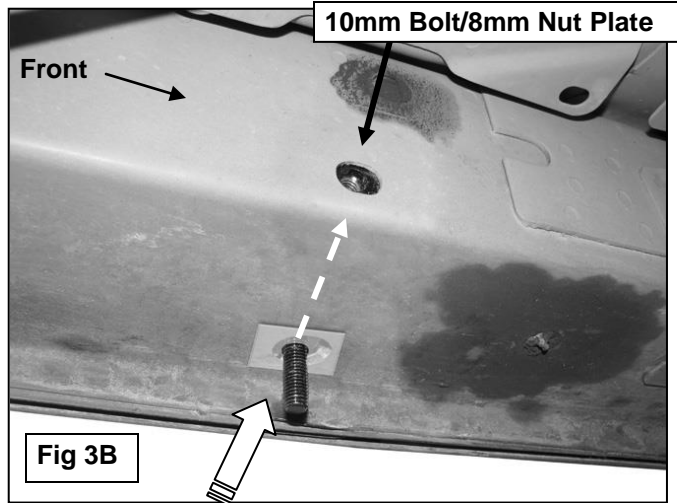
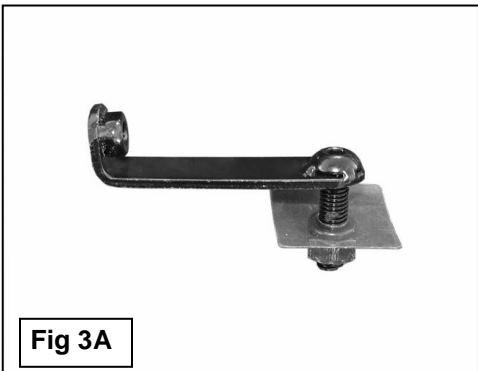

10mm Flat Washer  
10mm Lock Washer  
10mm Hex Nut

8mm x 30mm Hex Bolt  
8mm Lock Washer  
8mm Flat Washer

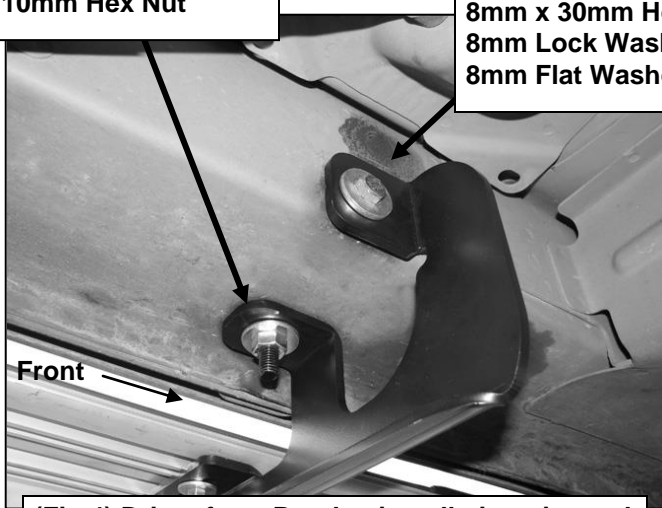

(Fig 4) Driver front Bracket installation pictured

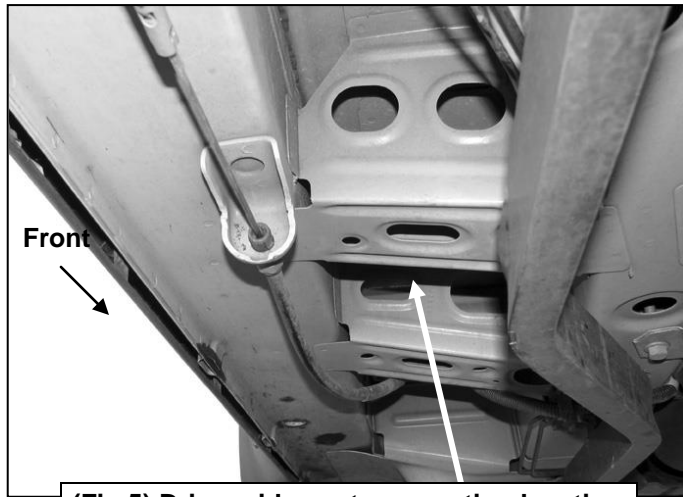

(Fig 5) Driver side center mounting location

VGSSB-1071-1261AL  
07-13 CHEVY TRAVERSE/GMC ACADIA/07-10 SATURN OUTLOOK/07-09 BUICK ENCLAVE  
(EXCL. ACADIA DENALI, 2010-13 BUICK ENCLAVE)

Driver Side Installation Pictured

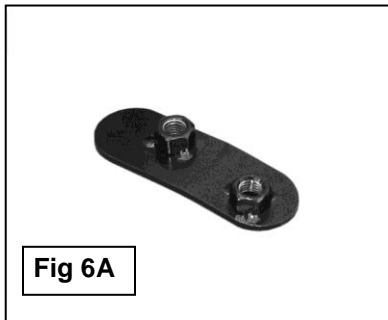

Line up offset hole in Nut Plate with single small hole

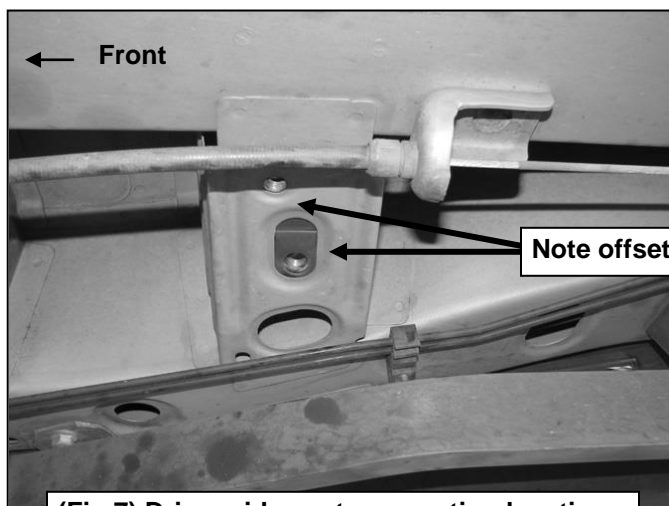
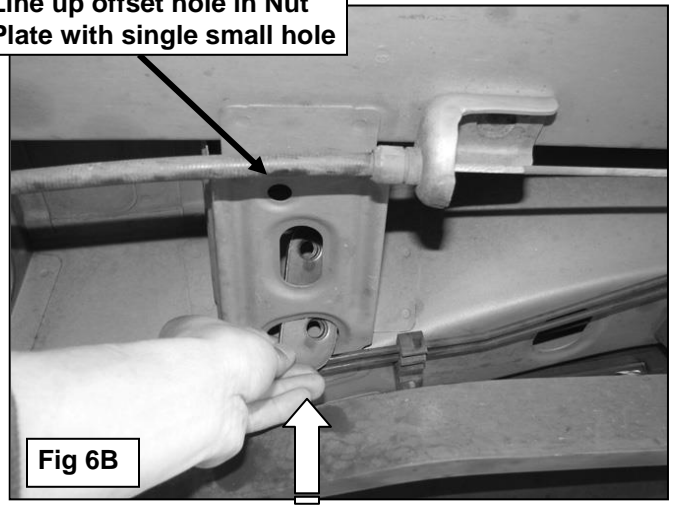

(Fig 7) Driver side center mounting location

- (2) 10mm x 35mm Hex Bolts
- (2) 10mm Lock Washers
- (2) 10mm Flat Washers

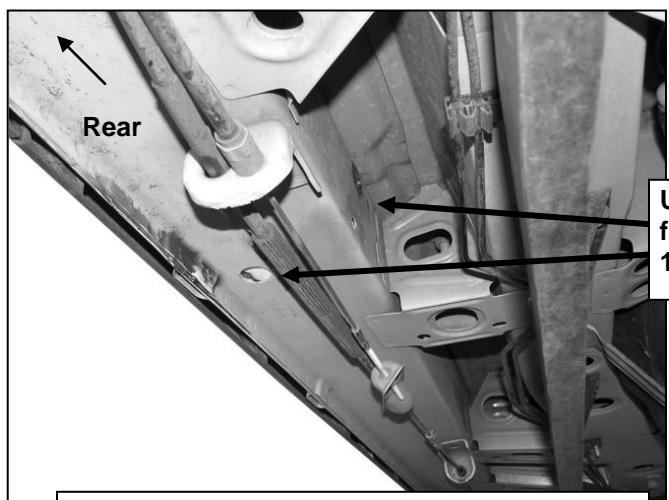
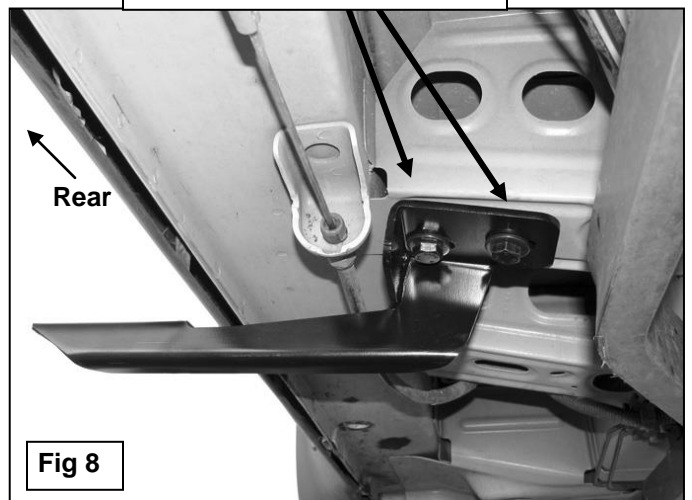

(Fig 9) Driver side rear mounting location

Use these (2) holes. Remove foam as necessary. Insert 10mm Bolt/8mm Nut Plate

VGSSB-1071-1261AL  
07-13 CHEVY TRAVERSE/GMC ACADIA/07-10 SATURN OUTLOOK/07-09 BUICK ENCLAVE  
(EXCL. ACADIA DENALI, 2010-13 BUICK ENCLAVE)

Driver Side Installation Pictured

10mm Flat Washer  
10mm Lock Washer  
10mm Hex Nut

8mm x 30mm Hex Bolt  
8mm Lock Washer  
8mm Flat Washer



(Fig 10) Driver side rear Bracket pictured

(2) 6mm Flat Washers  
(2) 6mm Lock Washers  
(2) 6mm Hex Nuts

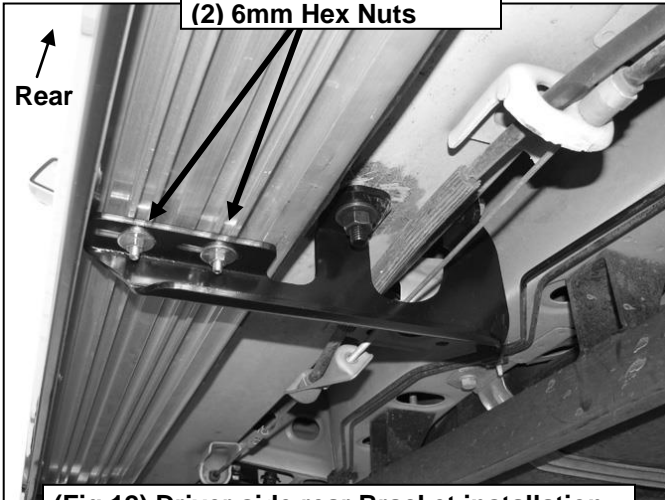

(Fig 12) Driver side rear Bracket installation

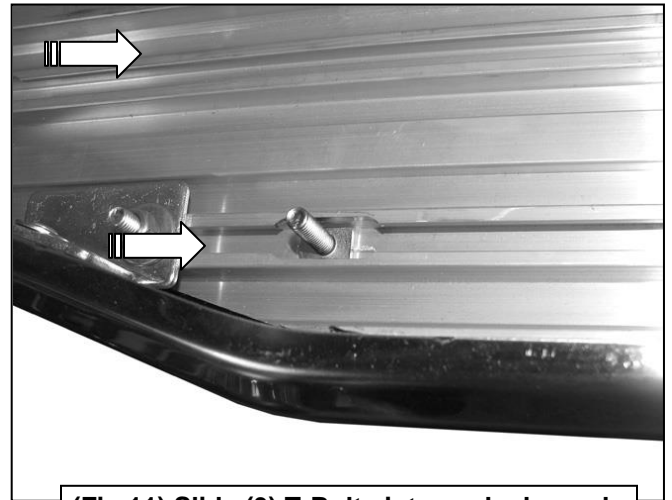

(Fig 11) Slide (3) T-Bolts into each channel



Installation Complete