











# INSTALLATION INSTRUCTION

## ATTENTION

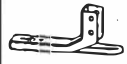
1. Please read this installation instruction before installing this part.  
When install it, please pay attention to protecting your vehicles.
2. When you use it, please check this parts at a fix time-lapse, such as one month or two month.

## PARTS LIST

No	Name	Photo	Qty	Remarks	No	Name	Photo	Qty	Remarks
①	Before the bar		1		⑧	Flat Washer		14	Φ12.5*Φ30*T2
②	DingGang		1		⑨	Bolt		4	M12*120
③	To protect a bumper		2 (lateral symmetry)		⑩	Lock Washer		10	M12
④	Loading code		2		⑪	Nut		4	M12
⑤	Edge bending		2 (lateral symmetry)						
⑥	Shoot the light		1						
⑦	Hex Bolt		6	M12*35					

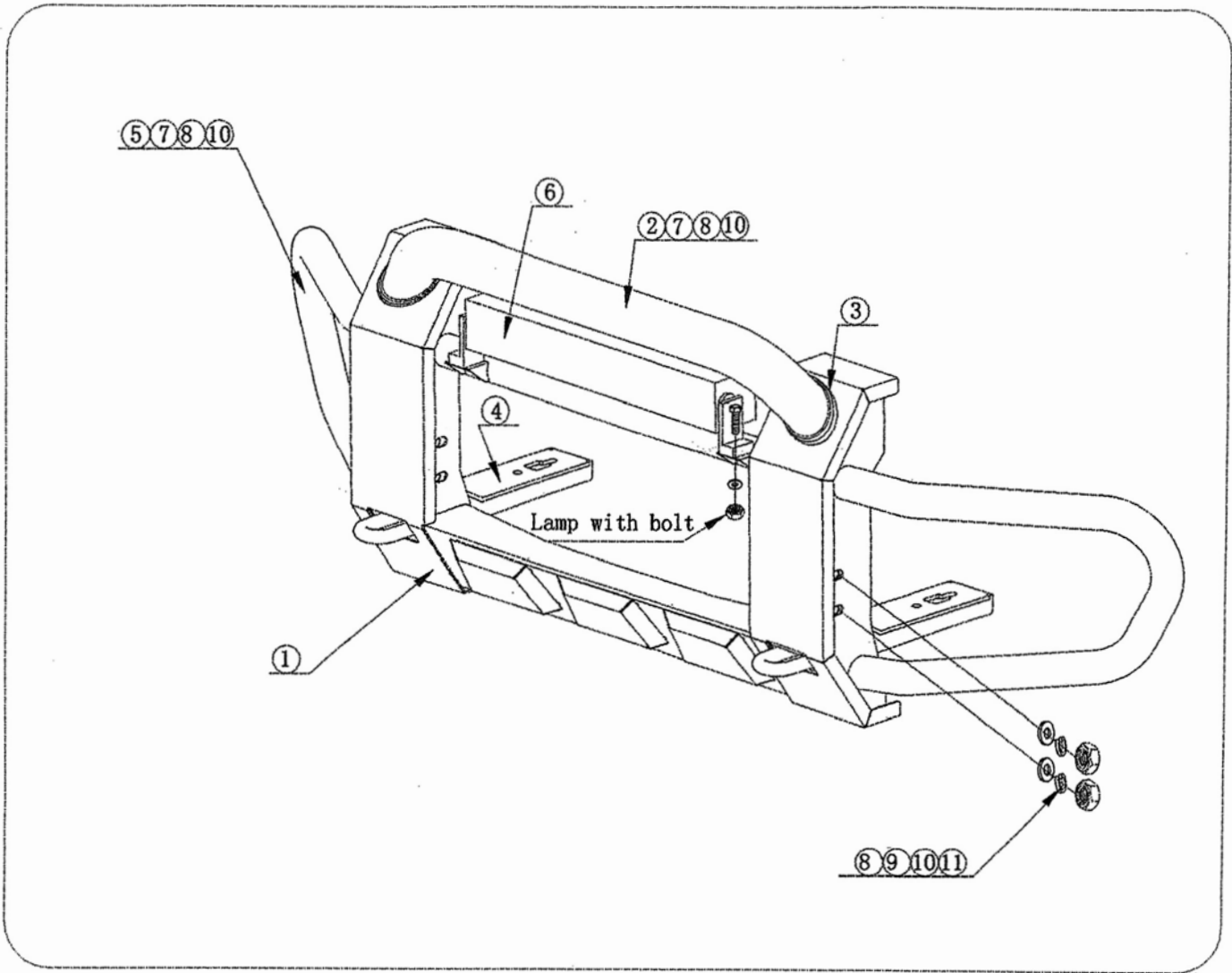

- STEP 1: Check the parts in the box carefully if match above list.
- STEP 2: Pls prepare the tools for installation, follow as: 4-6、8-10 wrench.
- STEP 3: Install the mount bracket on the girder of the car, and tighten it with M8 "T" Bolt with bread.
- STEP 4: Installation is finished.





